



Wireless Presentation Unit & HDMI Dongle - MTC-4500

User Manual



Tel: (RSA) 010 140 4900 / Email: sales@parrot.co.za
www.parrot.co.za

Feature List:

MTC-4500B:

- Support quad viewer on one display.
- Support VESA PC resolution input, auto-detecting.
- Can transmit PC's mirror/extended desktop or MacBook's mirror desktop.
- Can transmit smart devices' mirror, photos, videos, music etc.
- Support the MTC-4500 Teleporter "show-me" button.
- Support USB/HDMI/USB Type C plug-in auto configuration/pairing for MTC-4500 Teleporter "show-me" button.
- Support "Airplay" for apple device.

MTC-4000D, MTC-4000U and MTC-4000H:

- Support VESA PC resolution, auto-detecting.
- Can wireless transmit PC's mirror or extended desktop to base unit.
- Quick "Show-me" button to selection switcher the active signal of PC, less than 1s.
- "Show-me" button can independently step in/out the source of PC.
- Dual color LED, green indicates active source signal, red indicates power/link. (Hardware support on USB dongle, HDMI dongle and Type C dongle)

Version log:

Version	Revise time	Description
1.0	2020, Apr. 24 th	Created

Catalogue

1. Overview:	6
2. Specification:	8
3. Panel Layout:	10
3.1 Hardware Interface:	10
3.1.1 MTC-4500B Front Panel	10
3.1.2 MTC-4500B Rear Panel	11
3.1.3 Factory Reset	13
3.1.4 Dongle Front Panel	14
3.2 Software Interface:	17
3.2.1 Home Screen	17
4. Installation:	19
4.1 Installation methods for the Base unit	19
4.2 Wiring Diagram	21
4.3 Power Connection	21
4.4 Video Connection	22
4.5 Audio Connection	22
4.6 LAN connection	24
4.7 Usage of USB device	26
5. Quick-to-Start	27
5.1 Mobile device: Wireless Connection:	27
5.1.1 Enable portable hotspot:	27
5.1.2 Enable LAN connection:	28
5.2 Pairing transmitter with base unit	29
5.3 Mirroring:	30
5.3.1 PC/Lap-top	30
5.3.2 Mobiles Devices	35
5.4 Preview Window	38
5.5 Whiteboard & Annotation	39
5.5.1 Whiteboard	40
5.5.2 Annotation	42

6.	Web Setting Management Configuration	44
6.1	Network settings	47
6.1.1	Wireless network	47
6.1.2	Ethernet	57
6.1.3	Auto change password	58
6.2	Display & Audio	59
6.2.1	HDMI	59
6.2.2	Audio	61
6.2.3	Airplay screen quality	63
6.2.4	Screen display ID	63
6.2.5	Home Screen background image	64
6.3	Moderator control	65
6.4	System settings	67
6.4.1	Buttons:	67
6.4.2	Date & Time	67
6.4.3	Auto standby	69
6.4.4	Language	70
6.4.5	Reset	71
6.4.6	Configuration File	71
6.4.7	Series Port Setting	72
6.5	Security Settings	73
6.5.1	Security level	73
6.5.2	Login Password	74
6.5.3	Connection password	74
6.6	Firmware upgrade	75
6.6.1	Firmware Update	75
6.6.2	Automatic Upgrading	75
6.7	Other settings	76
6.7.1	Auto create launcher	76
6.7.2	Clear history after meeting	76
6.8	About device	77
7.	Updating MTC-4500	77

7.1	Check current firmware information	78
7.2	Upgrading firmware of base unit:.....	80
7.3	Upgrading and Pairing of Dongle:.....	82
7.4	Upgrading Launcher:.....	83
7.5	Clean left files of older versions of Launcher program in Lap-top	85
8.	Operation Guide	87
8.1	Mirroring PC desktop	87
8.1.1	Extended Desktop for Windows 10	87
8.1.2	Microsoft Windows PC/Laptop with Dongle	87
8.1.3	Microsoft Windows PC/Laptop without Dongle	88
8.1.4	Options for Microsoft Windows PC / Laptop – Extended Screen	90
8.1.5	MAC OS PC/Laptop with Dongle	93
8.1.6	MAC OS PC/Laptop without Dongle	94
8.1.7	Options for Apple MacOS, MacBook – Extended Screen.....	96
8.2	Transmitting IOS mobile device	97
8.2.1	How to use AirPlay?.....	97
8.3	Transmit Android device wireless	97
8.3.1	“MTC-4500” APK for Android.....	97
9.	WIFI Recommendation Setting	100
9.1	Check the WIFI config on base unit.....	100
9.2	Check the WIFI RSSI on dongle or Mobiles	100
10.	Problem Shooting	100
11.	Contacting Information	105

1. Overview:

MTC-4500 Set

MTC-4500 makes connecting or participate in a meeting by a most simple way, touching a button. It also allows the other to join in the meeting more actively. The result is to make the meeting more efficient and productive. A typical MTC-4500 contains one Base Unit MTC-4500 and two Transmitters e.g. MTC-4000U/MTC-4000D/MTC-4000H for choices.

MTC-4500 Set Components

A typical MTC-4500 Set includes two Buttons, one Base Unit, "MTC-4500" for Android" App and Airplay for IOS". Depending on the application or size of meeting room, user could purchase more kinds of buttons, e.g. USB dongle/ HDMI dongle/ USB Type C if they need.



ID	Name	Description
1	Base Unit	Host unit
2	Transmitters	For PC/Lap-top to share the desktop/extended desktop.
3	"MTC-4500" App for Android	For smart android devices to share the screen.

4	Airplay for IOS	For smart IOS devices to share the screen.
---	-----------------	--

Accessories List

ID	Name	Description
1	Antenna	2 pcs of antenna are included in the box. To avoid damage, they are not pre-mounted. The antenna can rotate for a better wireless connection.
2	Power adapter	International plug inter-changeable power adapter, of which the plugs includes US, Europe, UK, Australia standard.
3	Phoenix terminal	1 piece phoenix terminal for connecting the RS232 port of the rear panel.

The diagram of receiver and transmitter system as below.

System Operation-Normal mode

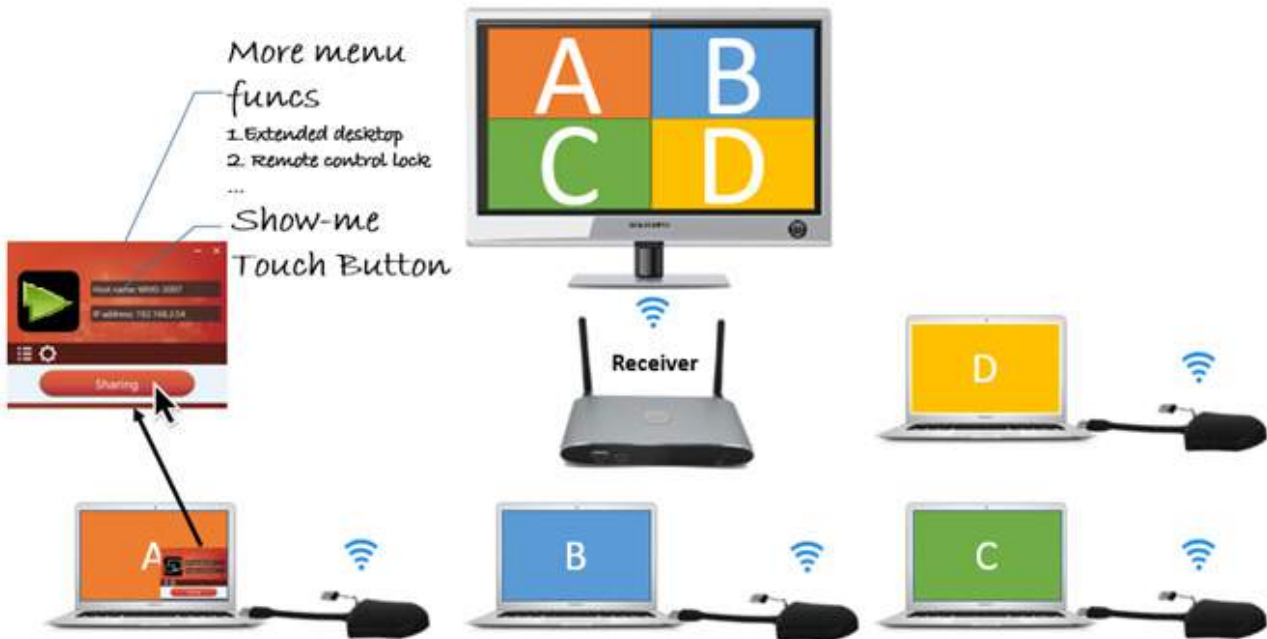

2. Specification:

Specification of Base Unit	
	
Base Unit Part Number	MTC-4500B
Video / Audio Formats	
Video Input	Wireless: MTC-4000D (USB Dongle), MTC-4000H (HDMI Dongle), MTC-4000U (Software Dongle)
Video Output	1 x HDMI
Video Output Resolution	3840 x 2160 @ 60Hz max
HDMI Format Compliance	HDMI 1.4/ 2.0
HDCP	HDCP 1.4/ HDCP 2.2
Audio Input Format HDMI	Embedded digital audio; 20kΩ impedance
Audio Output Format	De-embedded stereo analog audio; 20kΩ impedance
Connectors	
HDMI Output	HDMI 19-pin female connector x 1
Analog Audio Output	3.5mm audio female connector x 1
Power Input	DC 12V/2A
LAN	RJ45 x 2: 1000Mbps (PoE) x 1, 100Mbps x 1
USB	USB 3.0 Type-A x 1, USB 2.0 Type-A x 1, USB Type-C x 1
Antenna	Antenna connectors x 2
RS232	3.5mm Phoenix terminal x 1
Features	
Number of Window	4 windows max
Simultaneous Display	
Number of Video Preview	14 thumbnail windows
Number of Simultaneous Connections	16 max (*subject to environment)
Video Playback Frame Rate	20-60FPS
Wireless Transmission Protocol	IEEE 802.11 a/g/n/ac
Frequency Band	2.4GHz and 5GHz
Processing signal resolution	1080P @ 60Hz AirPlay for iOS devices 1080P @ 60Hz "MTC-4500" app 1080P @ 60Hz for optional dongle MTC-4000H 1080P @ 30Hz for optional dongle MTC-4000D and MTC-4000U
Mobile Capability	AirPlay, Free Android app
Encryption	AES 256 bit, RSA 1024 bit
USB HID	USB HID & touch screen support for controlling presentation
Control & User Interface	
USB	HID for mouse or touch screen
Ethernet	Web UI for system setting
RS232	RS232 commands
Mechanical	
Dimensions (W x D x H)	165mm x 95mm x 24.5mm (including antenna: 165mm x 125mm x 24.5 mm)
Weight	200g
Environmental	
Operating Temperature	+32° to +104°F (0° to +40°C)
Humidity (Storage/Operating)	20% to 90% (non-condensing)
Power	
DC Power	12V
Power Consumption	30W (max)
PoE	IEEE802.3af

Specification of USB Dongle



Part Number	MTC-4000D
USB Connector	USB 2.0 Type-A
Wireless	IEEE 802.11 n/ac
Processing Signal Resolution	1080p @ 30Hz
Streaming Distance	35 meters without obstacle between base unit and dongle
Storage	8GB, for "Launcher"
Button	Touch button
Indicator	Green/Red color back-lit LED
Dimension(L x W x H)	3.15" x 2.6" x 0.43" (80mm x 65mm x 11mm) With cable: 7.6" (198mm)
Weight	100g
Operating Temperature	+32°F to +104°F (0°C to +40°C)
Humidity(Storage/Operating)	20% to 90% (non-condensing)
USB Power	USB Internal 5V, 2W (max)

Specification of Software Dongle



Part Number	MTC-4000D
USB Connector	USB 2.0 Type-A
Wireless	Depends on the WiFi module of PC/Laptop
Processing signal resolution	1080p @ 30Hz
Streaming Distance	Depends on the WiFi module of PC/Laptop
Storage	8GB, for "Launcher"
Dimension(L x W x H)	2.78" x 0.67" x 0.41" (70.5mm x 17mm x 10.5mm)
Weight	30g
Operating Temperature	+32°F to +104°F (0°C to +40°C)
Humidity(Storage/Operating)	20% to 90% (non-condensing)
USB Power	USB Internal 5V, 2W (max)

Specification of HDMI Dongle



Part Number	MTC-4000H
USB Connector	USB 2.0 Type-A
HDMI Connector	19-pin male connector
Wireless	IEEE 802.11 a/g/n/ac
Processing Signal Resolution	1080p @ 60Hz
Streaming Distance	35 meters without obstacle between base unit and dongle
Storage	No
Button	Touch button
Indicator	Green/Red color back-lit LED
Dimension(L x W x H)	3.15" x 2.6" x 0.51" (80mm x 65mm x 13mm) With HDMI cable: 4.33" (110mm) and USB cable 8.27" (210mm)
Weight	100g
Operating Temperature	+32°F to +104°F (0°C to +40°C)
Humidity(Storage/Operating)	20% to 90% (non-condensing)
USB Power	USB Internal 5V, 2W (max)

Remark: All features and specifications are subject to change without notice.

3. Panel Layout

About this chapter

The installation chapter gives an overview of the interface of MTC-4500.

Overview

- Hardware Interface
 - MTC-4500B Front Panel
 - MTC-4500B Rear Panel
 - MTC-4000D/MTC-4000U/MTC-4000H Front panel
- Software Interface
 - Home Screen

3.1 Hardware Interface

3.1.1 MTC-4500B Front Panel



ID	Name	Description
1	Front USB connector	USB port, for dongle pairing, mouse control, USB touch screen etc.
2	Front Type-C connector	Type-C port, for dongle pairing.
3	Power Button	Turn on or off the device.
4	Back-lit LED indicator	Initializing indicates RED, power on indicates flashing GREEN, "Ready to share" indicates static GREEN, "Sharing" indicates static cyan.

USB port

- The USB port is used to update the software of the MTC-4500B.
- The USB port is used for pairing the dongle and base unit, when the transmitter is plugged-in.
- The USB port is used for connecting a mouse to create/upgrade Launcher by clicking **Download** button, hide SSID, PASS, WiFi IP and Lan IP by clicking **Info**, check **Security level button** and control PC source device, when a PC desktop is mirroring to the screen by plugging in the dongle.
- The USB port is used for connecting a USB-based touch screen to create/upgrade Launcher by clicking **Download** button, hide SSID, PASS, WiFi IP and Lan IP by clicking **Info**, check **Security level button** and control PC source device, when a PC desktop is mirroring to the screen by plugging in the dongle.
- The USB port is used for creating or upgrading Launcher by clicking **Download** button, when a USB stick is plugged in.

Type-C port

The Type-C port is used for pairing USB Type C dongle with base unit.

Mechanical fixture points.

The mechanical fixture points are located at the bottom of the base unit.

3.1.2 MTC-4500B Rear Panel



ID	Name	Description
1	Line audio output	2 channel analog audio output, Connect a 3.5mm mini-jack PC connector from this jack to the Line in jack of an audio system.
2	Rear USB3.0 connector	USB port, for USB dongle pairing, mouse control, USB touch screen etc.
3	Reset	Reset button to restore to the factory default setting.
4	HDMI output	Connect an HDMI cable from this port to an HD or 4K/HDMI2.0 display.
5	RS-232	Connect an RS-232 cable from this port to an RS-232 device.
6	LAN Ethernet port 1	100Mbps, Connect an Ethernet cable between this jack and a LAN to connect MTC-4500B to LAN.
7	LAN Ethernet port 2	1000Mbps, Connect an Ethernet cable between this jack and a LAN to connect MTC-4500B to LAN. Support POE.
8	DC Power socket	Connect the included power adapter to this socket, and connect the plug to an available electrical outlet.
9	Antenna fixture points	Screw up the included two antennas to these two ports.

USB port

- The USB port is used to update the software of the MTC-4500B.
- The USB port is used for pairing the dongle and base unit, when the transmitter is plugged-in.
- The USB port is used for connecting a mouse to create/upgrade Launcher by clicking **Download** button, hide SSID, PASS, WiFi IP and Lan IP by clicking **Info**, check **Security level button** and control PC source device, when a PC desktop is mirroring to the screen by plugging in the dongle.
- The USB port is used for connecting a USB-based touch screen to create/upgrade Launcher by clicking **Download** button, hide SSID, PASS, WiFi IP and Lan IP by clicking **Info**, check **Security level button** and control PC source device, when a PC desktop is mirroring to the screen by plugging in the dongle.

- The USB port is used for creating or upgrading Launcher by clicking **Download** button, when a USB stick is plugged in.

3.1.3 Factory Reset

- Start up the Base unit.
- When the *Home Screen* is shown up, press the reset button at the rear panel of base unit. Press this button with a pointed object, e.g. an unbent paper clip until the "*Factory Reset*" page is shown up as below, for at least 2 seconds.
- The Base unit will reboot after 3 seconds to be default configuration.
- If you do not have a picture, press and hold the reset button until the red LED in the top panel will lit, to execute the reset.

All previous settings will be lost and you will need to do the set-up once more.

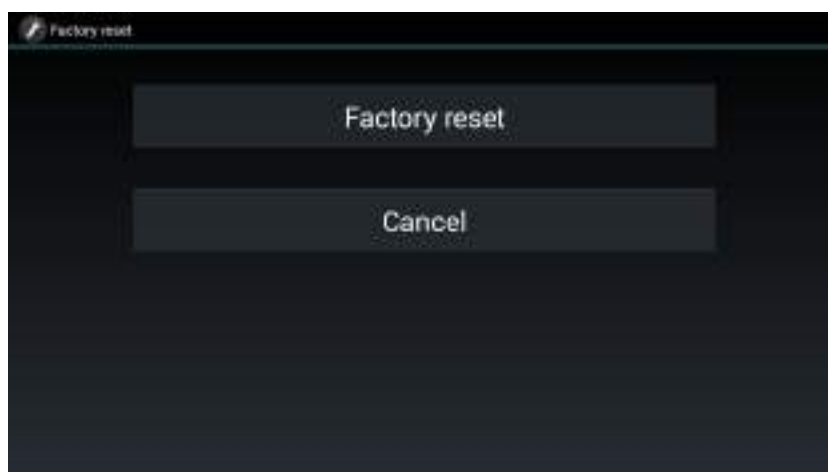

Default Configuration

- Ethernet:
 - DHCP: Enable
- Wireless network:
 - Frequency: 5GHZ
 - Channel: Auto
 - Auto change WiFi hotspot password: 5minute
- Display & Audio
 - HDMI resolution: Auto
 - HDMI CEC:
 - ◆ Device auto power off: ON
 - ◆ Base unit auto power on: OFF
 - Audio output: Jack&HDMI
 - Airplay screen quality: High
 - show device name and password when mirroring: OFF
 - show PCs user name when mirroring: ON

- Moderator Control
 - Add a sub-window bar to enable previewing the connected devices: ON
 - Real time preview: ON
- System settings
 - Date & time: Automatic date & time: use network-provided time
 - Auto Standby: Never
 - Language: English
- Security Settings
 - Security Level: Security level 1
 - Connection Password: 4-digits password beginning with 0000
 - Change admin password: admin(default)
- Other settings
 - Auto create launcher: Disabled
 - Clear history after meeting: Always

3.1.4 Dongle Front Panel

MTC-4000D, MTC-4000U and MTC-4000H are dongles, which are used for toggling the mirroring from personal PC or MAC desktop on the main screen.

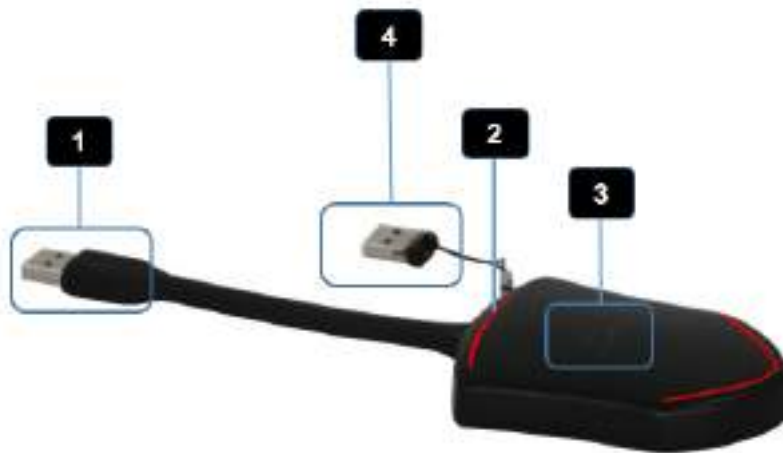

ID	Name	Description
1	USB connector	Using USB connect of the button can be plugged into a PC/Laptop (for sharing your screen) or the base unit (for pairing the Button to the Base Unit or Updating its software)
2	LED ring indicator	Indicates the status of the button

3	Touching Button	Press the button to start display the content of the PC/Lap-top's screen on the main screen. Touch the button during the meeting will toggle the sharing of the screen.
4	USB stick	Plugging USB stick into USB connector of MTC-4500B to create or upgrade Launcher. Plugging USB stick into PC to run MTC-4500 exe/APP. Program to mirror.

LED ring indicator behavior

- When LED indicator is static green, it's ready to mirror your PC desktop on the main screen.
- When LED indicator is static red, 1) it's mirroring your PC desktop on the screen, 2) pairing is done. You can now unplug the Button from the base unit.
- When LED indicator is blinking Green, it indicates 1) the button is plugged in the laptop and initializing or waiting for user to start the MTC-4500 application, 2) pairing/software upgrading of the button in the Base Unit is in progress.
- When LED indicator is Off (no light), it indicates 1) the button is not plugged in the PC/Lap-top; 2) the button is defective; 3) the USB port or computer might be defective.

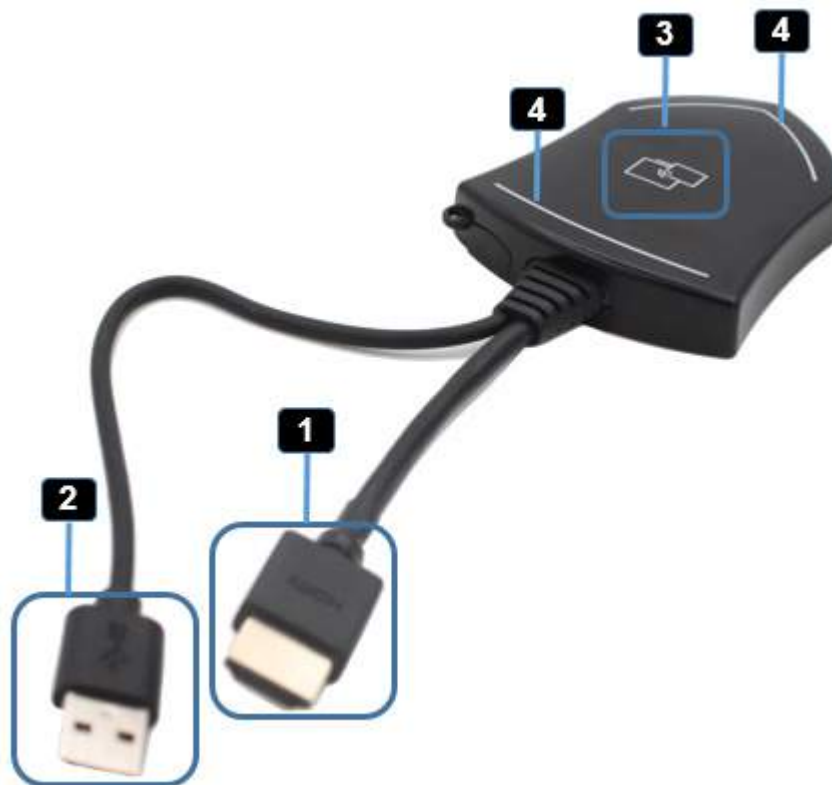

ID	Name	Description
1	HDMI connector	Using HDMI connector of the button can be plugged into a PC/Laptop for sharing your screen.

2	USB connector	Supply power, or plug into the base unit for pairing the Button to the Base Unit or upgrade the dongle.
3	Touching Button	Touch the sensor button to start displaying the content of the PC/Lap-top's screen on the main screen. Touch the button during the meeting will toggle the sharing of the screen.
4	LED ring indicator	Indicates the status of the button.





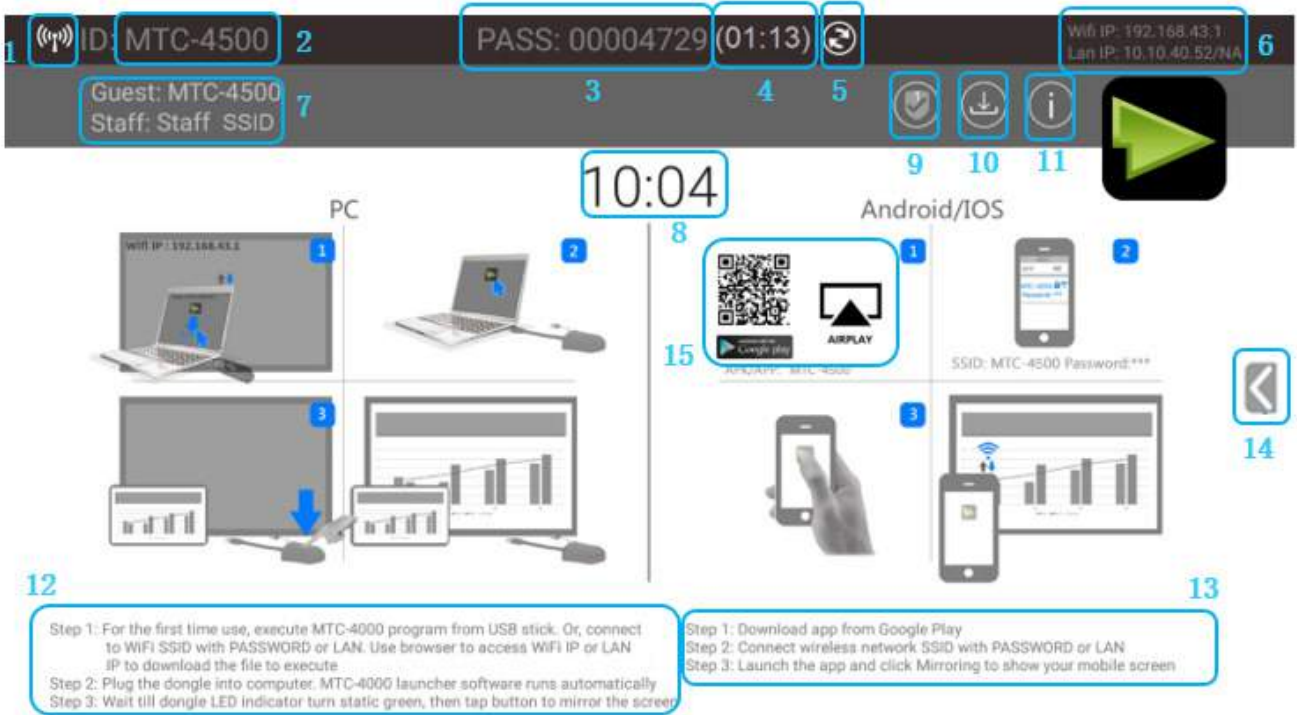

ID	Name	Description
1	USB connector	Using USB connector of the dongle can be plugged into a PC/Laptop for sharing your screen.
2	Type C connector	Using Type C connector of the dongle can be plugged into a PC/Laptop for sharing your screen.

3.2 Software Interface

3.2.1 Home Screen



ID	Name	Description
1	WiFi Indicator	<p>WiFi Direct mode: internal access point is enabled </p> <p>WiFi Infrastructure mode: "Client-Mode",  WiFi connection to router is established, icon displays the current signal strength.</p> <p>A secure WiFi connection is established, or connection to a router failed: </p> <p>WiFi is not available: </p> <p>LAN Infrastructure mode: access point is disabled</p>
2	ID	WiFi name or device name of the Base-unit access point.

3	PASS	WiFi password of base unit.
4	Password-timer	only displayed, when timer is active; time until the password is changed automatically.
5	Refresh WiFi-password	Generate new password manually for securing your WiFi network.
6	WiFi IP LAN IP	<ul style="list-style-type: none"> ● WiFi IP: address of base unit in wireless LAN ● Assigned IP: address of base unit in LAN; "N/A" = no connection to network
7	SSID: Guest SSID: Staff	<div style="background-color: #cccccc; padding: 5px; margin-bottom: 5px;"> Guest: MTC-4500 Staff: Staff SSID </div> Name of WiFi network for Guest and Staff , which allows mobile devices to connect with the base unit.
8	TIME	Show time, if LAN has access to a time server; even after disconnecting the LAN connection, the time is displayed until the device has been disconnected from power.
9	Security level	Security level 1-3, display ONLY; the security features of the displayed level are displayed in detail by clicking on the icon; the settings can only be changed by administrator in the webserver console setting menu.
10	Download Button	Creating & upgrading Launcher "MTC-4000.exe" for Windows, MAC to USB stick.
11	Info	Show status-bar (1) – (7) in Home screen showing/hiding
12	Windows / MacOS Quick Start	Steps to instruct how to transmit PC/Lap-top onto the main screen. First-time users must first install the starter program from the web page or from the USB stick one time.
13	Android/IOS Quick Start	Steps to instruct how to transmit smart mobile devices either powered by Android or IOS, onto the main screen.
14	Preview function of the screen contents of the participants with transmitter and mobile devices; White Board& Annotation function icon	Preview function of the screen contents of all connected transmitters and mobile devices; White Board and Annotation function.
15	Load "MTC-4500" App from Store	Scan QR-code for Android device and download the App from GooglePlay Store.

4. Installation

The installation chapter gives an overview of the different ways to install and connect MTC-4500 Base Unit.

Overview:

- Installation methods for the Base unit
- Table mounting
- Wall mounting
- Recommendations about antenna placement and orientation
- MTC-4500 Power Connection
- MTC-4500 Video Connection
- MTC-4500 Audio connection
- MTC-4500 LAN connection
- About USB device connection
- Wiring Diagram

4.1 Installation methods for the Base unit

Introduction to the installation methods:

The Base unit can be installed in different ways in a meeting room.

- Table mount
- Wall mount

The articulated antennas are removable. They can rotate for better wireless connection.

Attention: For optimal performance, install the Base unit close to the display and avoid obstacles between the Base unit and the Transmitters.

Necessary tools

- A drill (type of drill depends on the type of wall)
- Flat screwdriver
- Additional screwdriver that matches the mounting screws (mounting screws not included in the package)

Necessary parts

- 2 mounting screws
- 2 plugs

How to install

1. Drill two holes in the wall as indicated on the drawing.
Horizontal distance: 177 mm ± 0.15
2. At the bottom of Base Unit, turn in 2 flat screws into 2 holes to be fasten enough.

Note: Mounting screws and plugs are not included in the MTC-4500 box . The type of screws depends on the type of wall (stone, wood, plasterboard, ...) you are mounting the Base Unit to. Make sure the head of the screw is not larger than the hole in the bottom of base unit.

3. Place MTC-4500B on the wall and fixate the base unit with the 2 unfixed screws.

Antenna placement rules

- The antennas should be oriented vertically, so perpendicular to the ceiling and parallel to the walls.
- The antennas should be installed far enough (at least 50cm/1.6ft) from metallic surfaces to avoid unwanted reflections and far enough (at least 1m/3.3ft) from other radio equipment that operates in the same frequency range, e.g. other WiFi access points, cordless telephone, microwave ovens,.... It is also best to install antennas at least 15 cm (6 inches) from concrete walls.
- The most favorable situation is a direct line of sight between antennas and Buttons. Any obstruction will cause the signal to follow a longer propagation path, which can result in performance degradation.
- Due to the particular radio pattern of the dipole antennas, the antennas should not be placed just above potential positions of MTC-4500 users. As a result, the advised position for the antennas is at the side of the meeting room.

4.2 Wiring Diagram

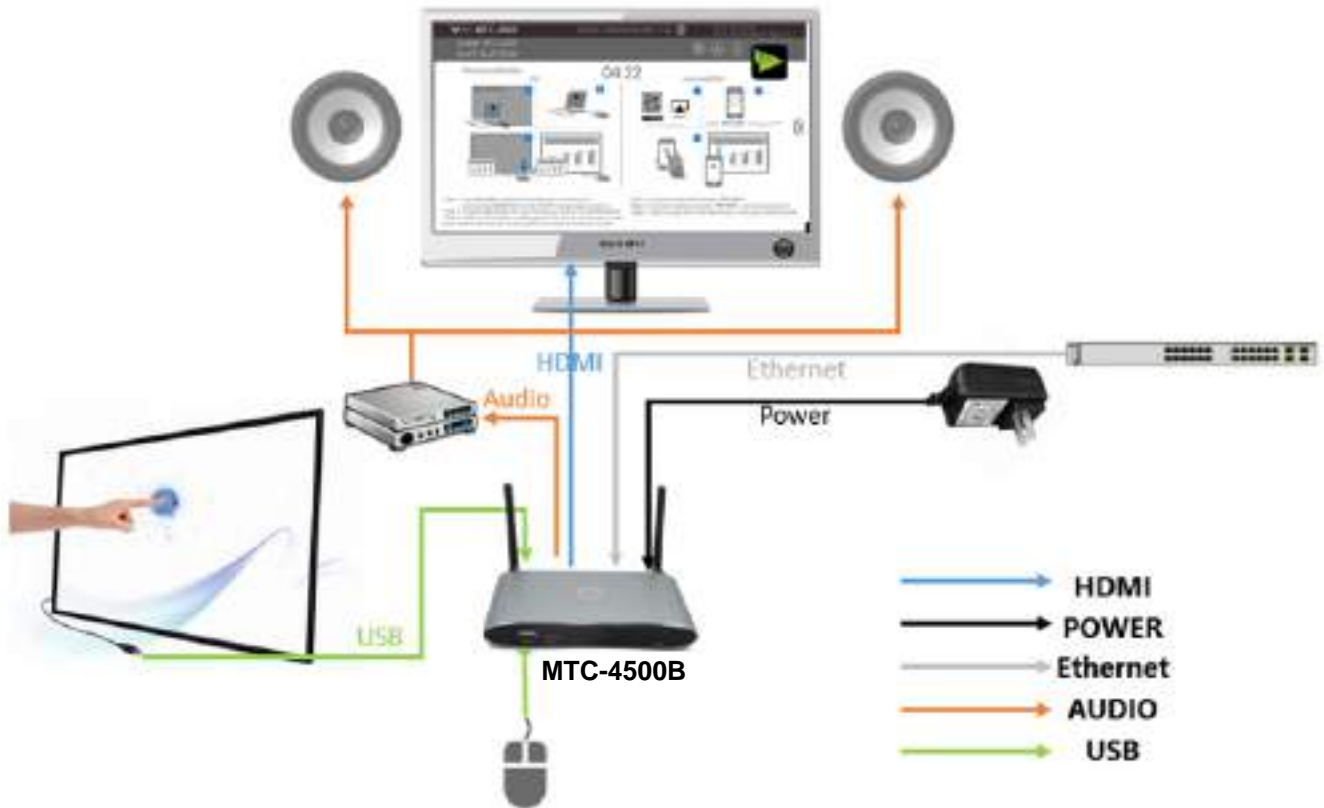

4.3 Power Connection

The Base unit can be powered by the external universal power adapter.

How to connect the external power adapter

1. Plug the power connector to the power adapter to the power input connector of the Base Unit
2. Choose the appropriate power plug (US, UK, EU or AU) to be installed on the power adapter,
3. Connect the power cable plug into the wall outlet.



Note: Once the base unit is powered, it starts up. From now on please use the POWER button with Status LED on

front of Base-unit to switch ON or OFF.

Power over Ethernet

If the LAN Ethernet switcher support POE (Power over Ethernet), it could power up the Base-unit instead of using the external power adapter. (LAN2 Port is support POE.)

4.4 Video Connection

1. Connect the **HDMI Output** of base unit to a 4K or Full-HD display by a HDMI cable.
2. Connect the power adapter to the base unit **DC power socket** and connect the other side plug to an available electrical outlet and switch the base unit on.
3. After started, the system show the **home page**, as shown below.

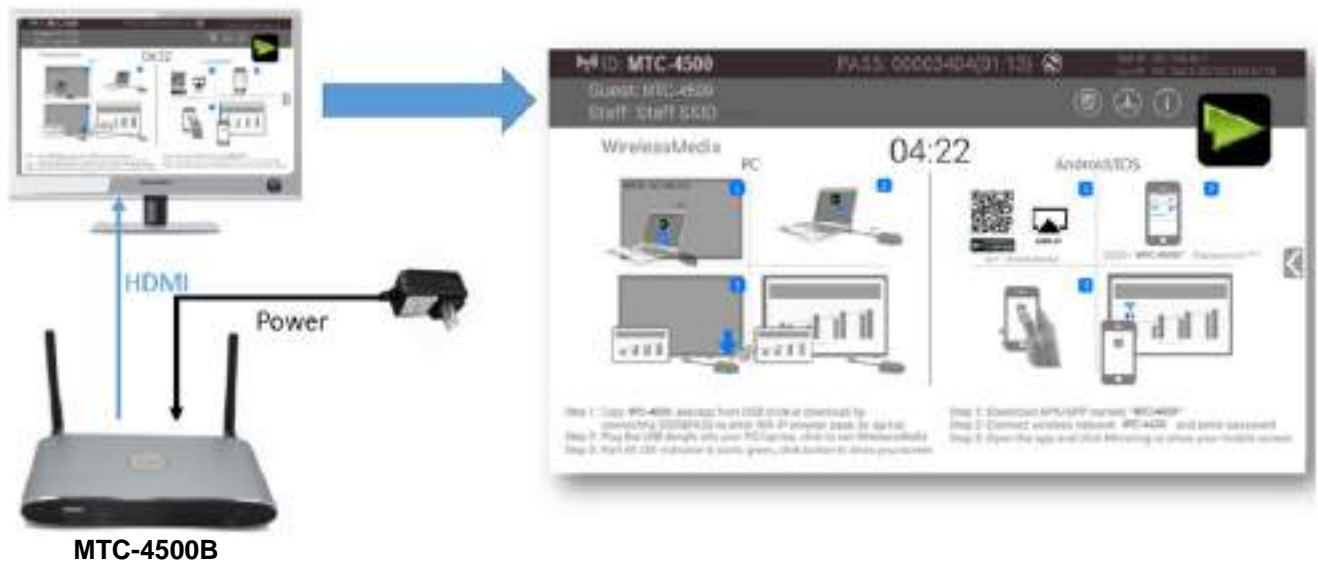

4.5 Audio Connection

MTC-4500 transmitter can transmit the audio output of the PC/Lap-top, re-direct and send to the Base Unit together with the video signal. The audio will be output at line levels from mini jack socket 3.5mm connector and via the HDMI output connectors simultaneously.

It's up to the user to decide whether or not to send the audio signal together with the video signal.

Audio via HDMI output

When your display/projector is connected via HDMI and it support audio together with video, then a separate

audio connection is not necessary. The audio signal is sent together with the video signal to the display. The system is shown as below.



How to connect separate audio

1. Connect an audio cable with mini jack socket 3.5mm connector into the audio of the Base Unit
2. Connect the other side to the meeting room's sound system.

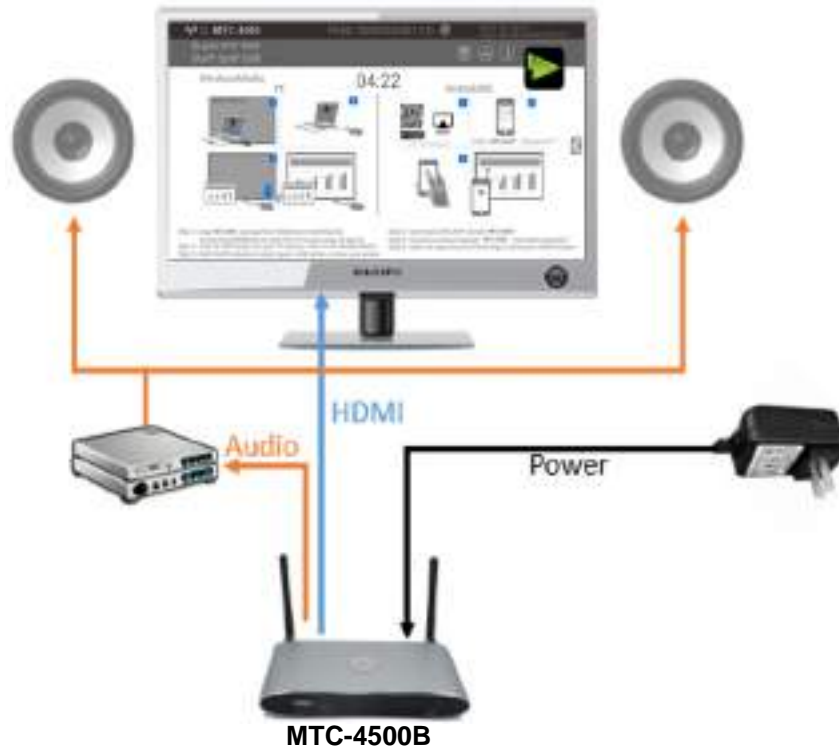

Sound is not sent out

MTC-4500 button will keep capturing and send the audio of PC/Lap-top, since PC/Lap is successfully mirroring desktop to the main screen.

1. Please be sure the button is static green and the PC/Lap-top is sharing on the screen
2. Check *Setting* configuration, to adjust the *Volume* set in *MTC-4500 setting* tab.

PC/Lap Sound

As default set, MTC-4500 will mute the internal speaker of PC/Lap and route the audio to the base unit, after PC/Lap is successfully mirroring desktop to the main screen, in order to avoid the repeated audio.

When click the button to stop sharing, local loudspeaker will return to previous status, you could adjust the volume on your PC/Lap.

Note: *If you want to keep the internal speaker of PC/Lap still while route the audio to the base unit, please click the audio mute icon in the status bar to turn on the internal speaker.*

4.6 LAN connection

The Base Unit can be connected to a local network or directly to a PC/lap-top. For normal operation, a LAN connection is not necessary. When needed, it's suggested to connect MTC-4500B to the Internet.

1. Connect a network cable with RJ-45 connector into the LAN port of Base Unit.

2. Connect the other side to LAN.
3. If the LAN Ethernet switcher support POE (Power over Ethernet), it could power up MTC-4500B than using the external power adapter.

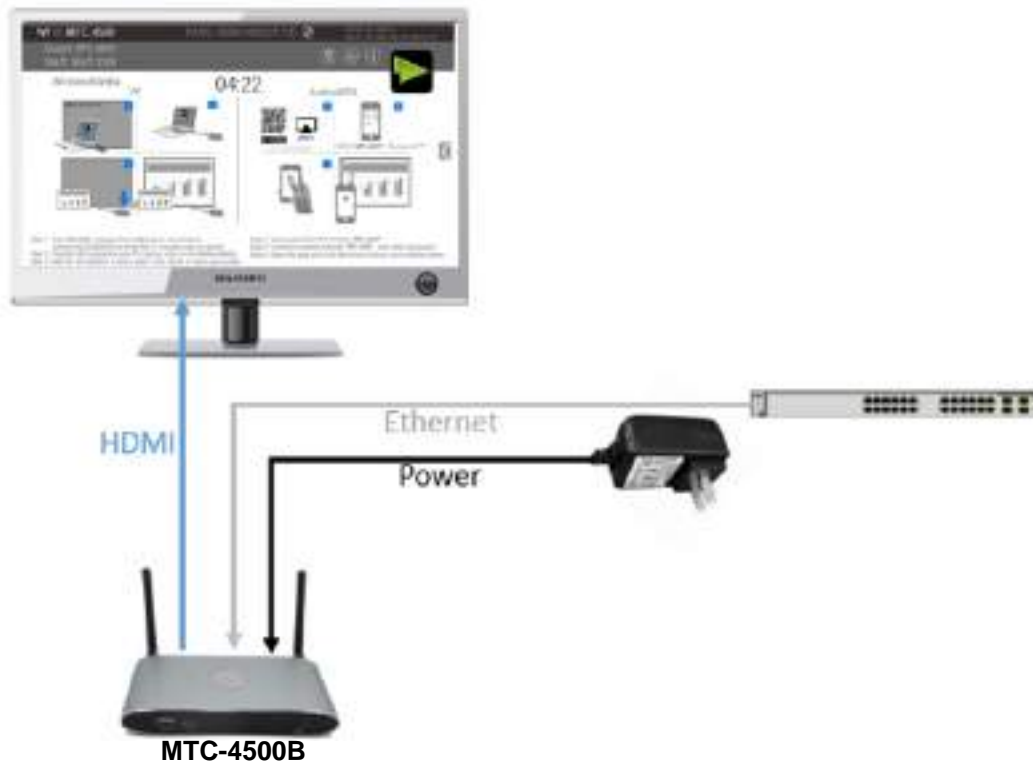

The LAN connection can be used for:

- Network integration of Base Unit in guest or company network.
- Telnet control the Base Unit.
- Maintenance purpose.
- Over-The-Air -Update (OTA) of firmware of Base-unit.

4.7 Usage of USB device

Please use a USB Mouse or Touchscreen:

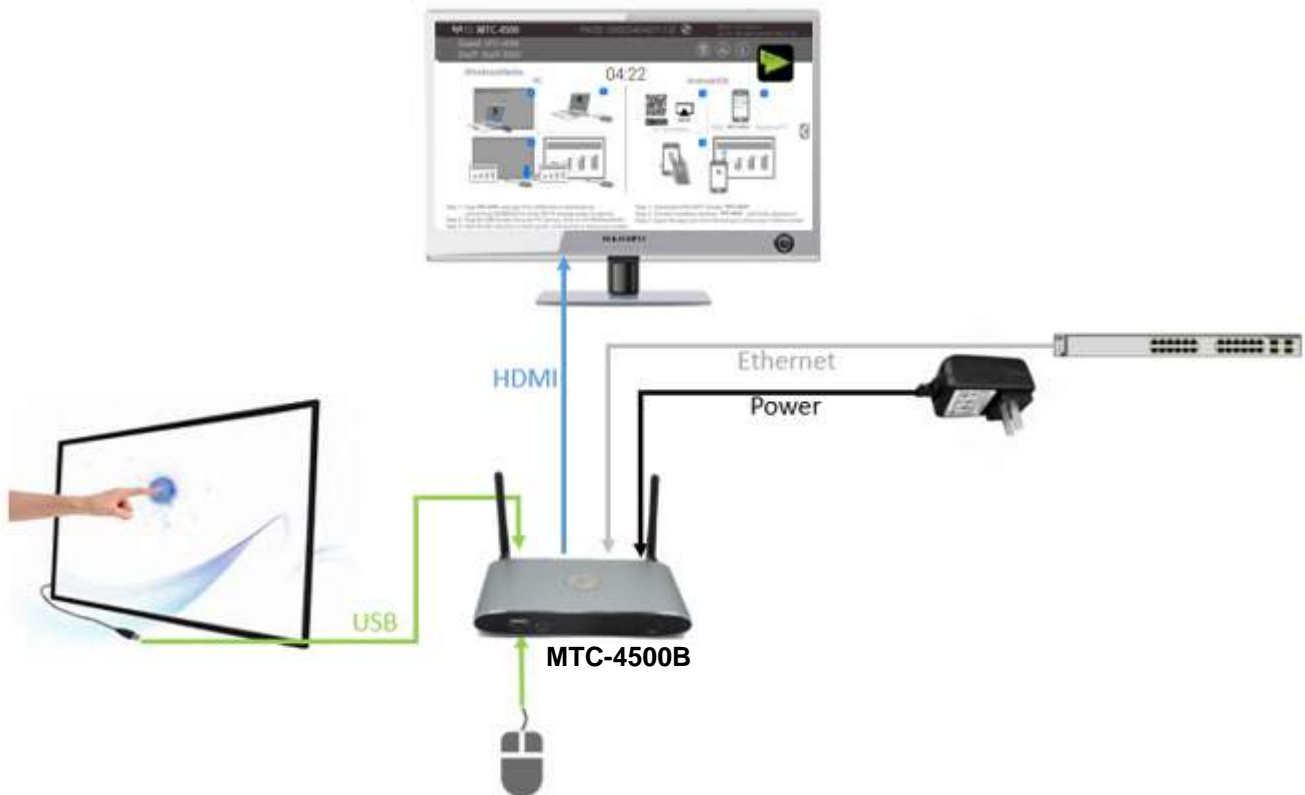

1. To configure the **Security level check button, DOWNLOAD BUTTON, INFO.**
2. To control the sharing PC/Lap-top.
3. To activate system upgrading
4. For white board or annotation during a presentation, MTC-4500 transmits Video, Audio and the USB-HID function for mouse-control and click-function of a touchscreen. Connect touch-interface of your screen to the USB-port on your laptop or PC.

USB control

USB mouse for configuration menu

- Single click to select.
- Right-click to back to the Home Page.

Touch screen

- Click to select.
- Long press to open the contextual menus, as double-click or click the right button of a USB mouse.

5. Quick-to-Start

5.1 Mobile device: Wireless Connection

1. Download the application namely "MTC-4500" (for example scan QR-Code in Home screen) in Android Google Play market for Android mobile device.



2. For IOS devices, use Airplay to mirror the desktop.
3. MTC-4500 provides two ways to discover the MTC-4500B for mobile devices.
 - a) Portable hotspot, to connect the hotspot to connect the MTC-4500B.
 - b) LAN connection, to connect the MTC-4500B and mobile both in LAN network, to discover and connect to MTC-4500B.

After Factory reset, MTC-4500 starts in standard configuration "Wireless Direct Mode" ("Linked Single Network"), where the base unit creates its own wireless access point, to which all the transmitters connect. This is typical for quick setup, temporarily installations or for small business meetings with a small number of meeting rooms.

The WiFi icon  for "WiFi Direct Mode" appears in the top status bar of the Home screen. The SSIDs for these hotspots appear in the Start screen of MTC-4500:

Guest: MTC-4500
Staff: Staff SSID

Guests and staff have access to the internet when LAN is enabled.

5.1.1 Enable portable hotspot:

Check the SSID and PASS (Password) are shown on the Homepage, as shown below.



5.1.2 Enable LAN connection:

Be sure the base unit MTC-4500B is connected to the Network. When *Local IP* shows an active IP address, such like 10.10.40.52, it indicates base unit is successfully connected to the LAN and get an appointed IP address.



Note: When it shows "N/A", means the MTC-4500B is not connected to the LAN (Local Area Network) by CAT cable or it failed to get an available IP address by the corporation router.

Please refer to the LAN-settings in Ethernet, as below.

Default password for entering the Main menu on webserver console is "admin".

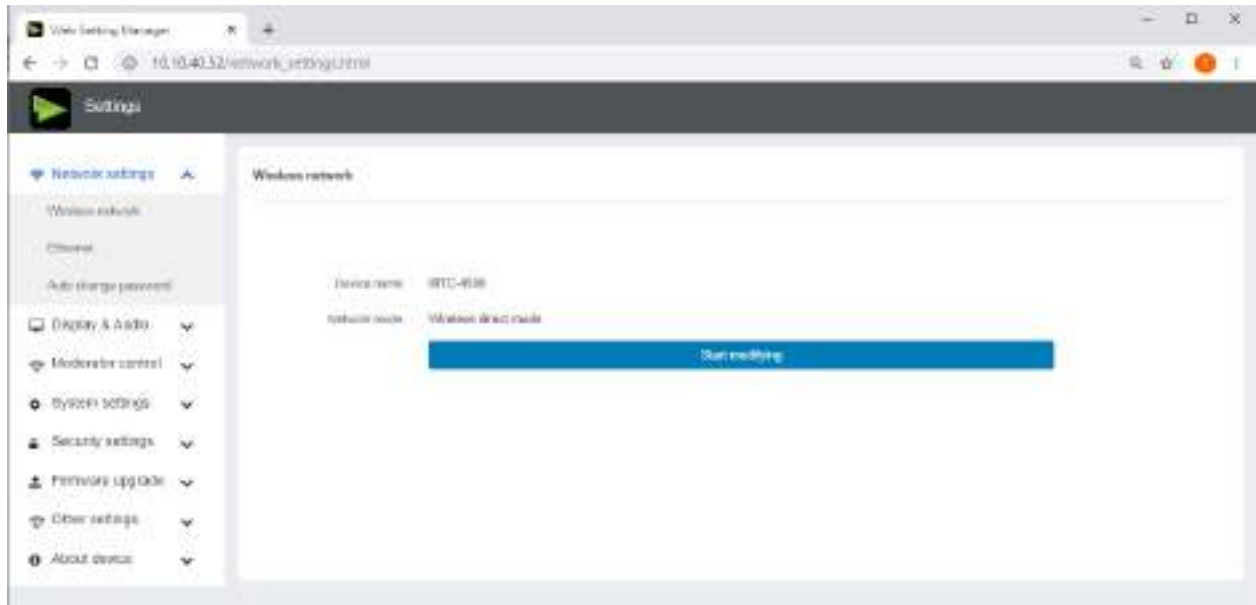

5.2 Pairing transmitter with base unit

1. Connect the USB of MTC-4000D (USB Dongle) to either of the 2xUSB port of MTC-4500B, MTC-4000U (Software Dongle) to USB port/Type C port, MTC-4000H (HDMI Dongle) to USB port, to pair all the transmitters with base unit. The home page displays as shown below.



2. When plug in transmitters, the message table shows "Dongle is booting, please wait..." as shown below



3. Then, the message table shows "Pairing, please wait..." as shown below



4. After completing the pairing, the message table shows "Succeeded to pair!" on the home page, as shown below. Then, please un-plug the transmitters and use it for the mirroring on your laptop.



If error-message "Configuration fail" is shown, please check the connection of USB/type C to keep stable after plug-in, and try again.

Note: After each changing the SSID/WiFi channel in menu, all the transmitters must be paired again! When you buy additional transmitters or when a transmitter should be assigned to another Base-unit, the transmitter must be paired again. A transmitter can only be paired to one Base-unit at a time. The transmitter will always make connection to the Base-unit it was last paired to.

5.3 Mirroring

5.3.1 PC/Lap-top

Driver-based Transmitter

MTC-4000D (USB Dongle):

1. Use a universal USB stick to create a "Launcher", which is stored in the base unit.

- Connecting the USB stick to base unit and click the **DOWNLOAD** icon on the homepage to download "MTC-4000-windows.exe" for windows PC/Lap-top, "MTC-4000-macOS.app" for MacBook, "user manual" and "MTC-4500.apk". Plug the USB stick to the USB port of your PC or lap-top to copy the relative "Launcher" as above to PC or lap-top. Continue with step 4.

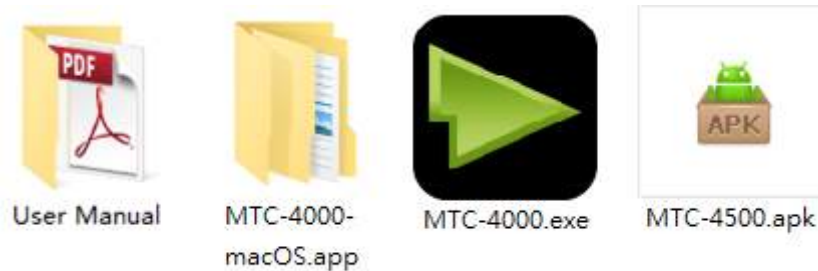

- Or connect PC to SSID & PASS of base unit which are shown on Homepage and browse the WiFi IP or Lan IP from PC, which are also shown on Homepage. Select to download the "MTC-4500-windows.exe" for Windows PC/Lap-top or "MTC-4000-macOS.app" for MacBook. Continue with step 4.
- Execute MTC-4000.exe from pc or lap-top. Till the transmitter shows a static green LED indicator, or till you see a visual button of "Launcher", showing "Ready to share", you could click the transmission button MTC-4000D or visual button to start "Sharing" the desktop on the main screen.

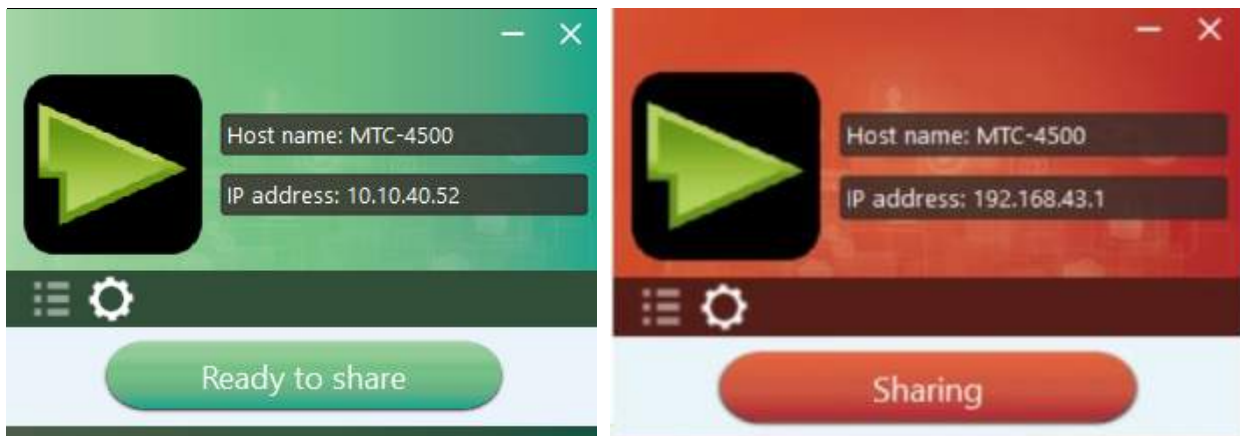

- Click the transmitter again, to stop mirroring, LED shows green again.

Note: For second time user, once plug transmitter into PC, it will run automatically to be ready for share.

ATTENTION:

- For sensitive customer, please download the "MTC-4000-pro.exe" instead of "MTC-4000-windows.exe" for the steps above.

2. "MTC-4000-pro.exe" doesn't run automatically after the plug-in of the dongle, but require user to manually click and execute the "MTC-4000-pro.exe" every time.

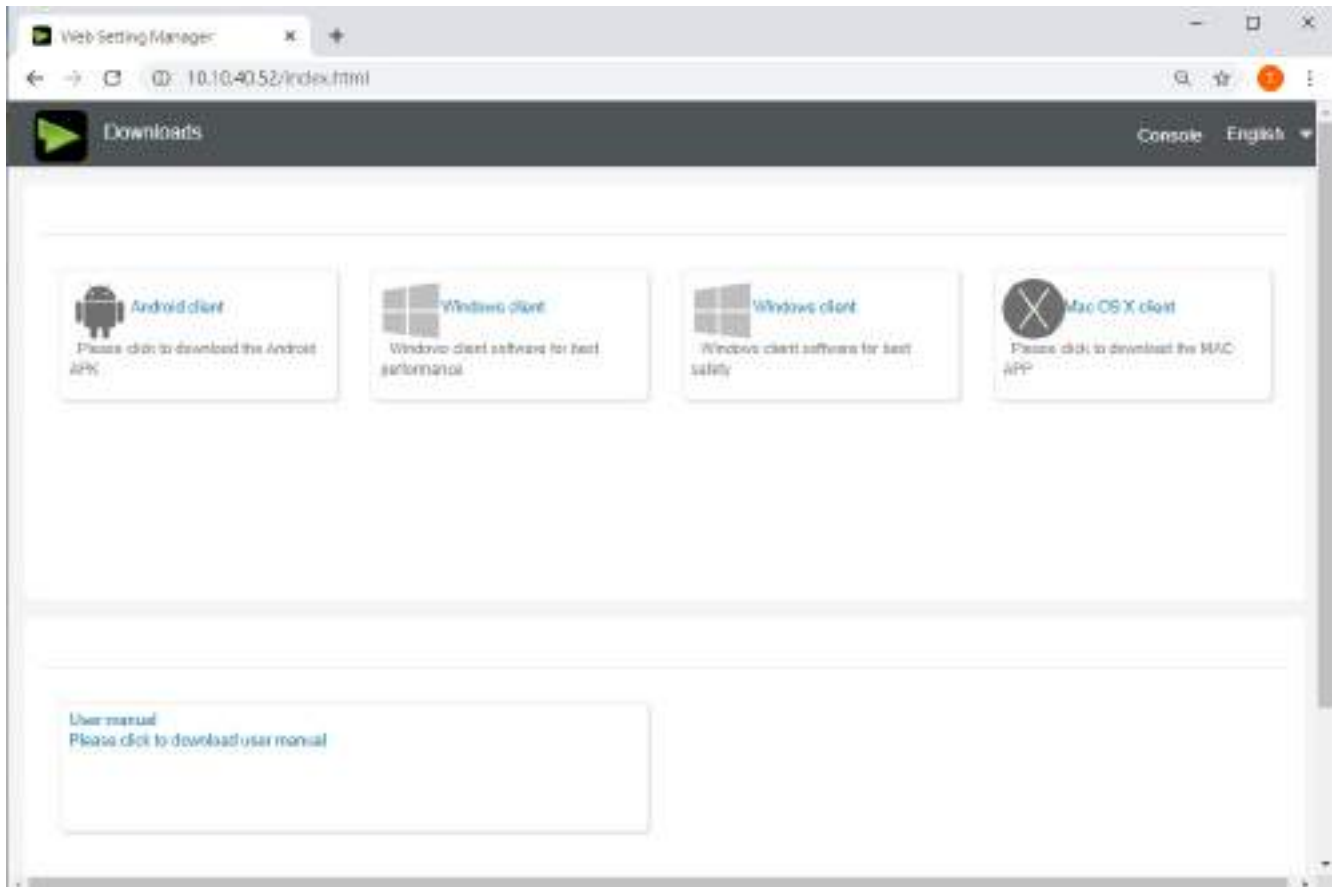

MTC-4000U (Software Dongle):

1. Plug MTC-4000U into USB/Type C port to pair with base unit. The "MTC-4000.exe" for windows PC/Lap-top, "MTC-4000-macOS.exe" for MacBook will be auto downloaded into MTC-4000U.

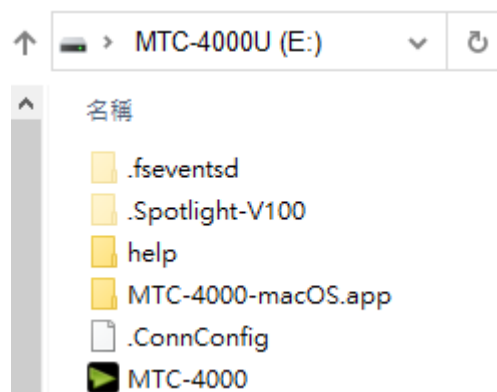

2. Plug MTC-4000U into PC/Laptop/MacBook and click the "Launcher" to run. MTC-4000U will auto change PC's WiFi to the target base unit WiFi. No need to manually change PC's WiFi. It will pop out the message bar to enter the password to connect.



3. It will show "Ready to share", click to share the desktop to screen.



Note: for second time user, MTC-4000U will automatically run to share screen, no need to click "Launcher".

Non-Driver based transmitter

MTC-4000H (HDMI dongle):

1. Plug USB port of MTC-4000H to base unit to pair.
2. Plug USB port and HDMI port of MTC-4000H to PC/Laptop/MacBook. (USB port for power)
3. Till the transmitter LED turn static green and touch to share the screen or click the visual button on bottom right corner of PC.

Quad view mirroring:

MTC-4500B base unit can mirror 4 sources onto main display simultaneously, which supports PC/Laptop and mobile devices.



5.3.2 Mobiles Devices

Sharing on Android devices

1. Open the "MTC-4500" application.



MTC-4500

2. Connect your mobile device to one of the displayed WiFi networks.

Guest: MTC-4500
Staff: Staff SSID

3. Open the "MTC-4500" application in your mobile device, and you will see the Home Page of "MTC-4500" as shown below. and click the device list refresh button  for Android, which is highlighted in red circles as shown below:



4. Select the base unit you want to connect, enter password and mirror by clicking "Share Screen".

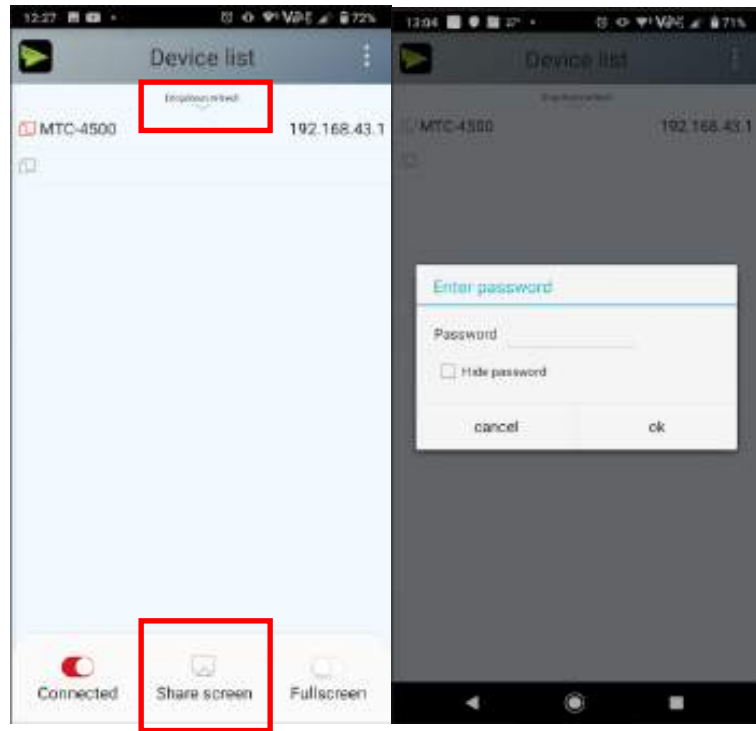

5. After completing the pairing, it shows OSD "Welcome ***" on the home page. For example, if we connect it by a HUAWEI-PLA-AL00, it shows a "Welcome HUAWEI-PLA-AL00" on screen, as shown below.



6. Now you can mirror your desktop of your mobile.
7. Click again the button "Share Screen" to stop mirroring.
- ✧ Click the connected device name to check the base unit status and base unit firmware version.

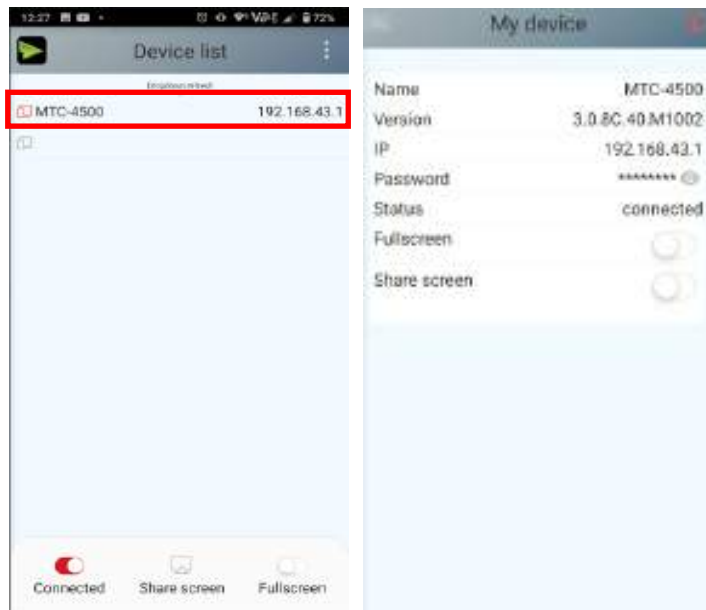

Click "Fullscreen" to be full screen in the main screen when more than one signal is connected and shared.



✧ Click the upper right corner icon, check the "MTC-4500" application version information.

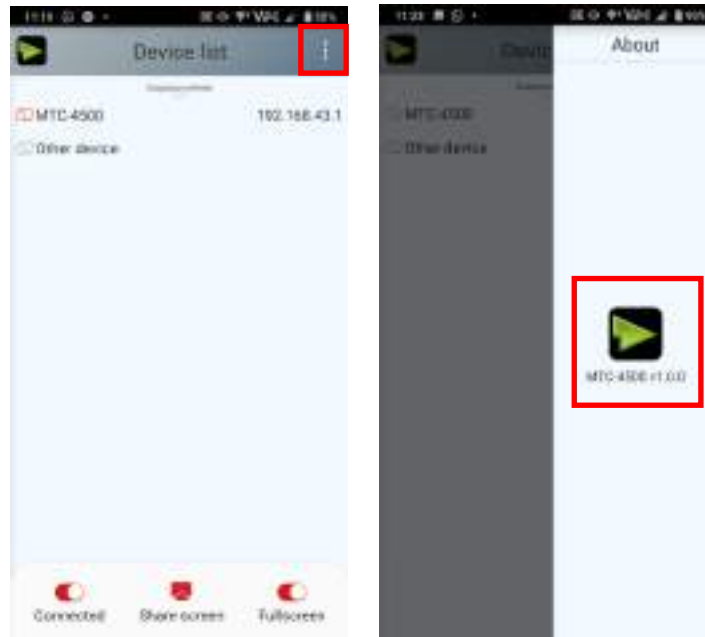

Sharing on IOS devices

1. With **AirPlay** technology, user can stream his screen or music, (YouTube-) videos, pictures ... wireless to Base-unit. Connect your iOS device with the same WiFi network from MTC-4500.

For IOS devices, activate the control center. Click the **Airplay** icon  on your Apple device and select the target MTC-4500B base unit, to start mirroring through MTC-4500B base unit to the main screen.





It will show OSD on home screen after connecting successfully.



5.4 Preview Window

At touch-screen or with mouse of Base-unit, you can click on LEFT or RIGHT-arrow (2), to show the small preview-windows as a bar on the right edge of the screen, or to hide them, if they are disturbing. Once the preview windows are activated, you see live-pictures (1) of all connected transmitters and android devices via “MTC-4500” APK at the right edge of the screen. Just scroll UP or DOWN (3) to see further preview pictures.



As soon as presenter is clicking with mouse of Base-unit, or clicking with finger at touch-screen, the appropriate participants of the meeting is activated, another click at the arrow shows his picture at the main screen in full format. A red frame is shown for the active picture. The button  indicates play button, click to show screen. The button  indicates step out screen, click to stop mirroring the current signal. The button  indicates full screen, click to be full on main screen. The button  indicates sound of mirrored video, click it to mute or unmute the connected signal.

5.5 Whiteboard & Annotation

Whiteboard and **Annotation** requires an HID compatible device, such as interactive white board or interactive touch screen. It is easy to use, makes collaboration in your business more productive and effective: documents can be easily written, edited, captured and shared.



Whiteboard: write all your ideas and share the digital notes with anybody. Different colors of pen and background can be selected.

Annotation: draw or write annotations in overlay within your documents, presentations. Save and share everything that was discussed. Different colors of pen can be selected.

How to start Whiteboard or Annotation mode

The "Preview window" in Home Screen to start this mode.

Tap (click) the LEFT-arrow (1), located on the right side of the screen, and select

Whiteboard  or Annotation icon  icon in (2).

Icon  in (2) indicates "information", click to check the base unit SSID, password, WiFi IP and Lan IP address when some device are sharing on main screen. This info will show on main screen at least 20s then will disappear automatically. In order to let other attendees join into meetings as well.



The toolbar for Whiteboard or Annotation appears in the bottom of your screen. If another user is mirroring, the Whiteboard & Annotation function is closed.

5.5.1 Whiteboard









Click on the icon to enter the white Whiteboard page. You can create free drawings with your finger at touch screen, mouse (multi-touch capability).

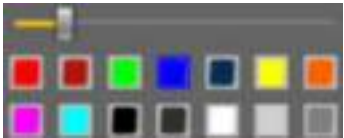

Use the toolbar to select one of the following functions.

ID	Icons	Function
----	-------	----------

<p>Tool bar 1</p>		<p>Add an empty page</p> <p>Delete the actual page</p> <p>Display previous or next page</p>
<p>Tool bar 2</p>		<p>Undo: one step backward in changes</p> <p>Redo: one step forward in changes</p> <p>Erase part of drawings or annotation, change diameter by a longer tap</p> <p>Clear the entire drawing/writing on the screen</p> <p>Pen allows writing/drawing in different colors</p> <p>Draw basic geometric shapes</p> <p>Select color of board, the drawing will be kept</p>
<p>Tool bar 3</p>		<p>will pop up, when "Pen" or "Draw shape" or "Select color of board" is selected, for individual change of size of Pen, Shape or color.</p>



Tool bar 4		Save the current screenshot on local storage (PNG+WMN)
File options	  	<p>Close Whiteboard to go back to Home screen, actual project can be saved on local storage (WMN)</p> <p>File options:</p> <ul style="list-style-type: none"> ● Open WMN-file from local storage and continue/edit an older project ● New project ● Save as WMN on local storage in unit, it will be erased after POWER-OFF ● Import from U disk stored project (WMN) ● All pages are saved as PDF on local storage ● Clear history – delete all whiteboard & annotation files on local storage

5.5.2 Annotation

Click on icon  to enter the Annotation function.



Use the toolbar to select one of the following functions.

ID	Icons	Function
Tool bar 1		<p>Undo: one step backward in changes</p> <p>Redo: one step forward in changes</p> <p>Erase part of drawings or annotation, change diameter by a longer tap</p> <p>Clear the entire drawing/writing on the screen</p> <p>Pen allows writing/drawing in different colors</p> <p>Draw basic geometric shapes</p>
Tool bar 1		<p>Close Whiteboard to go back to Home screen, actual project can be saved on local storage (WMN)</p> <p>Close Whiteboard to go back to Home screen,</p> <p>Save the current screenshot on local storage (PNG)</p>

Download the drawings to connected users

Scan the QR-code with your mobile's camera or enter the given IP-address in a browser. If the network connection is set properly, you will get the saved files on Base unit, which you can download as PNG file. The possibility for download will be closed after you click OK. You can copy data to USB disk and put this USB disk into the Base-unit and import with "Import from U disk" to the Whiteboard-section.



 <http://192.168.43.1:38238/> 

Files on base unit:/111

name	size	modify date	action
0.png	361.5 KB	19-12-02 PM04:57	download

6. Web Setting Management Configuration

Connect base unit ID & Password or LAN IP to laptop, to enter WiFi IP browser page to configure settings of base unit. The "MTC-4000.exe" and "MTC-4000-Pro.exe" for windows PC/Lap-top, "MTC-4000-macOS.app" for Mac OS X, "user manual" and "MTC-4500" for Android can be downloaded here.

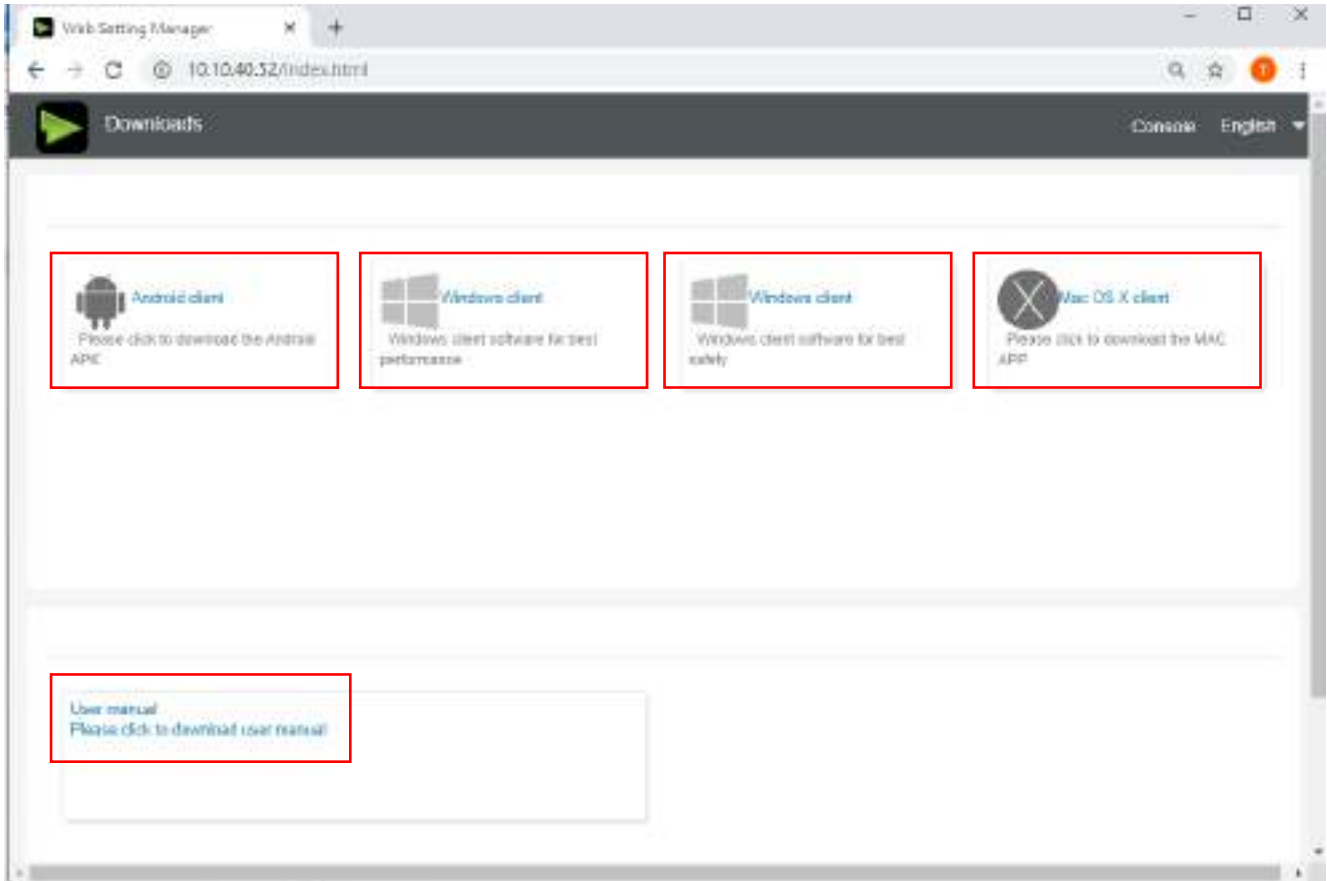

Click "Console" on the top right corner to enter into menu to configure.

A password is required to enter the configuration menu. The default password after Reset is "admin". You can change the password in menu "Security setting".

Note:

If user has forgotten his password, you need to make a Factory Reset to restore "admin" as password.

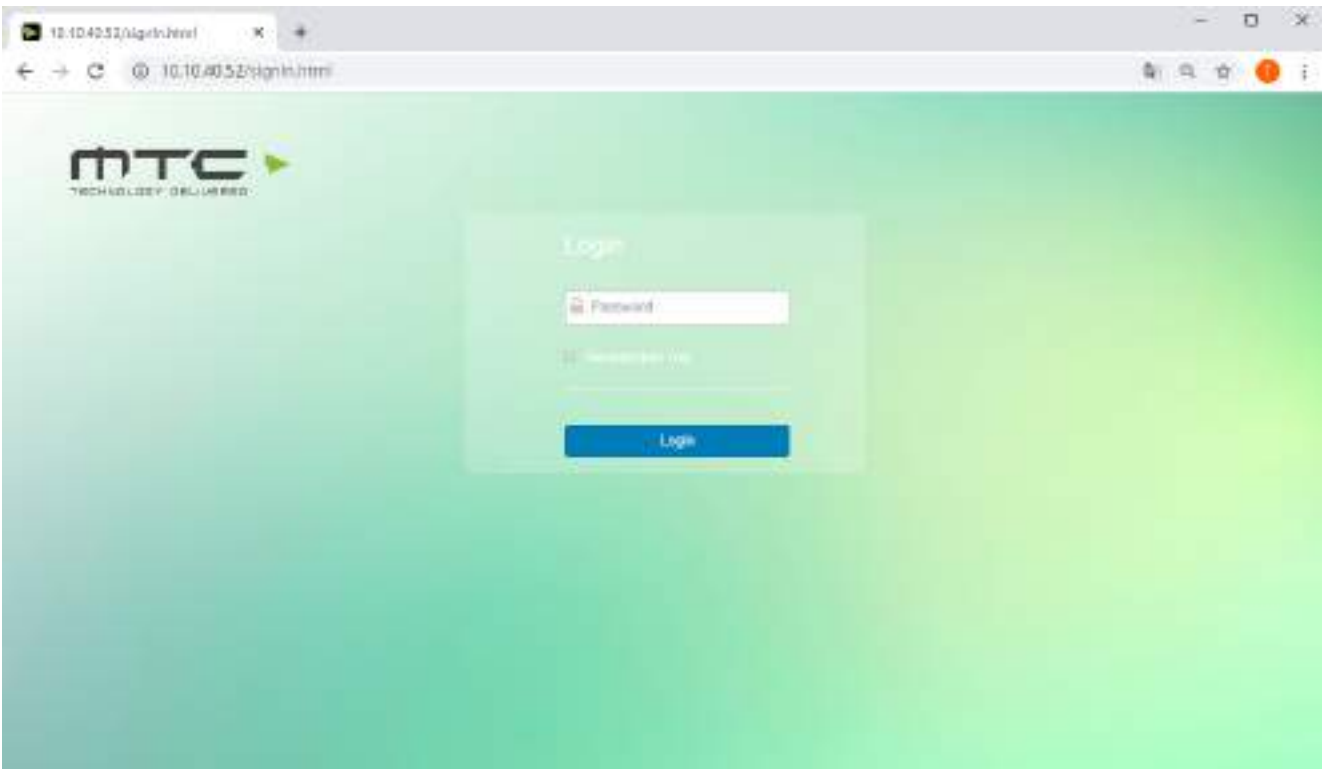
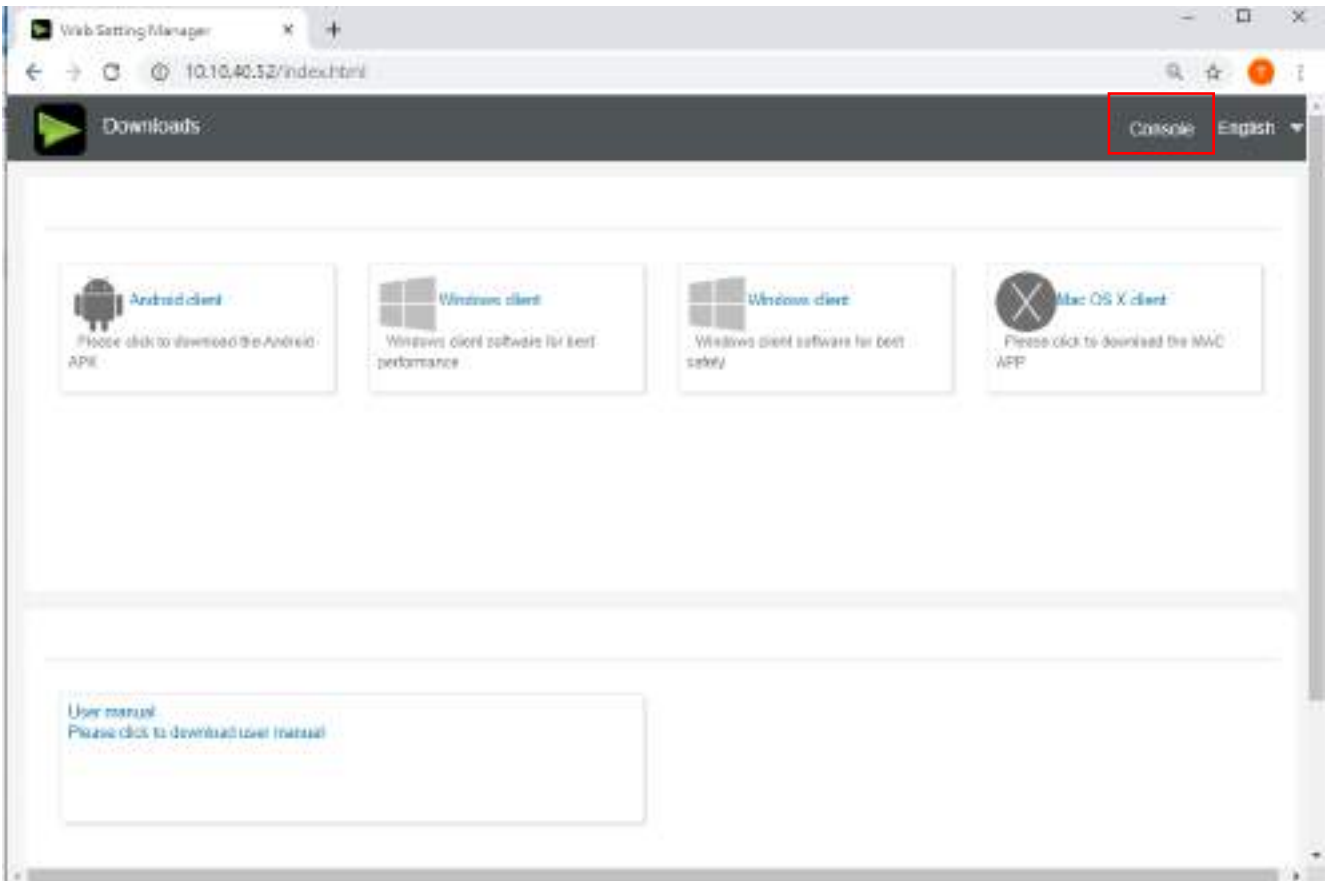

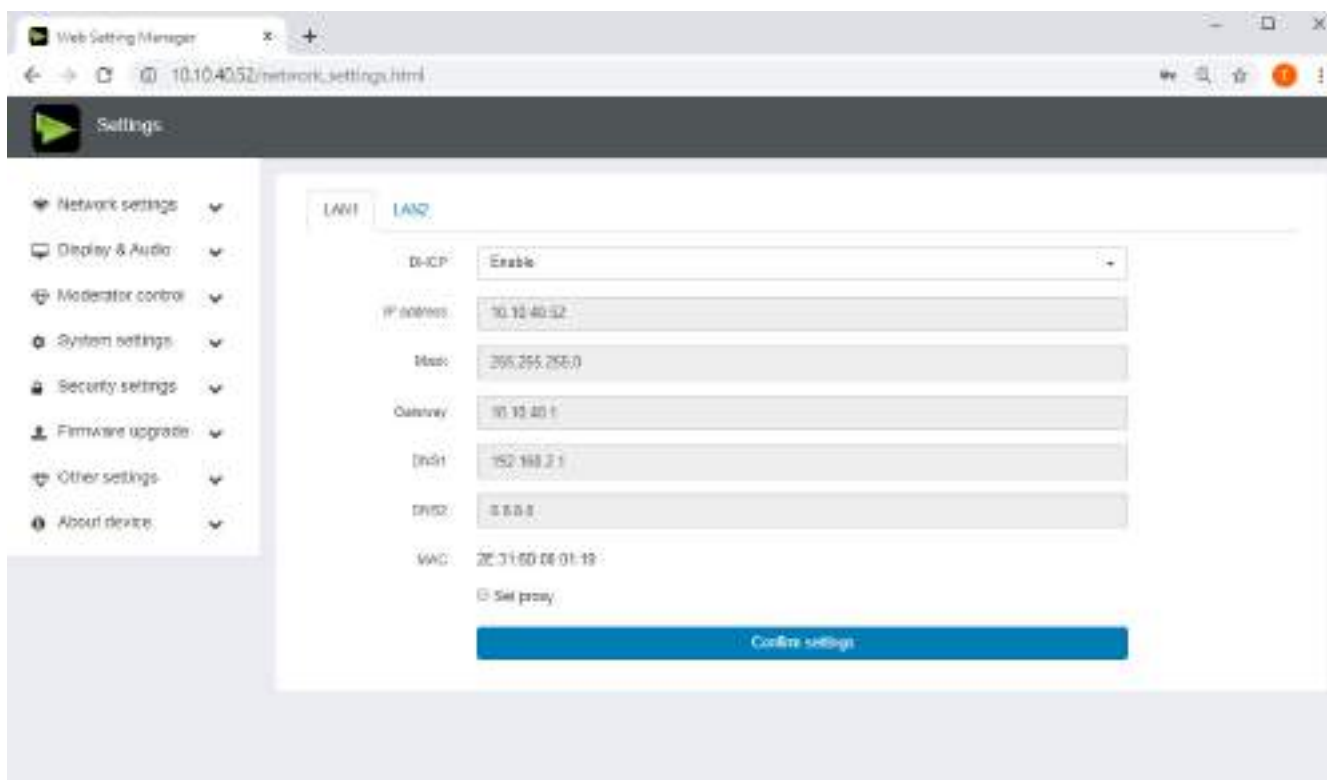

The main interface of Setting is shown as below, including **Network settings, Display & Audio, Moderator control, System settings, Security settings, Firmware upgrade, Other settings, About device.**

6.1 Network settings

6.1.1 Wireless network

To take the full benefits of the MTC-4500 possibilities, MTC-4500B should be properly integrated in the organization's network (company/university/school). This wizard allows user to create a custom configuration for integration of MTC-4500 into the existing wireless infrastructure in larger organizations.

Segmented Dual Network, is to provide two segmented routing ways to connect to the base unit simultaneously and separately, including wireless WIFI network (normally connected to Guest/untrusted network) and wired LAN network (normally connected to the corporate/trusted network).

A typical Segmented Dual Network topology is shown as below:

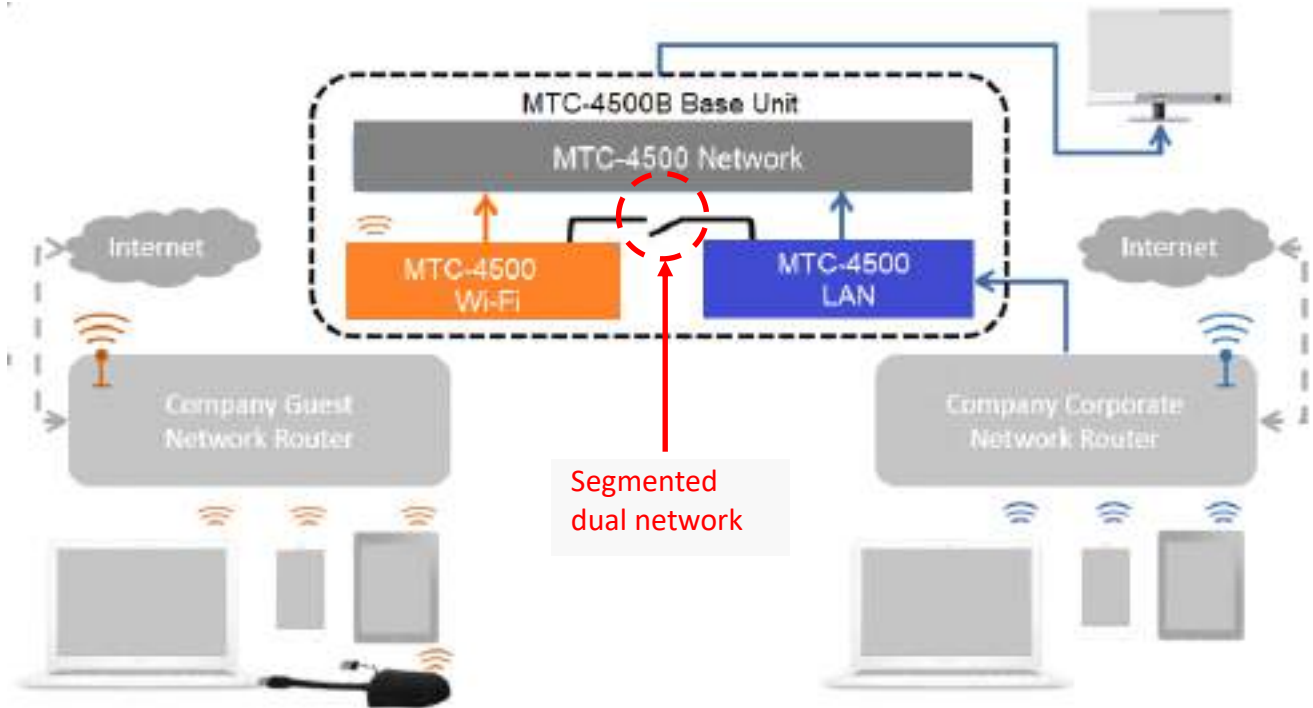

6.1.1.1 Wireless network configuration wizard

Enter a device name for the Base-unit. We recommend to take a descriptive name, if you have more than one MTC-4500 installed. The default name is "MTC-XXXXX".

wireless network

Only "a-z", "A-Z", "0-9", "-", "_" and space are legal character.

Click "Next step". The following three connection methods are available:



6.1.1.2 Wireless Direct Mode

After Factory Reset, MTC-4500B base unit starts up in the **default Stand-Alone “Wireless direct mode”** configuration, where the Base-unit creates its own wireless access point, which all transmitters use to connect.

This is typical for a quick setup for small group meetings. The WiFi icon  for the “Wireless direct mode” is displayed in top status-bar of Home screen. **Guest** connect to the access-point of Klick & Show, while **Staff** can also connect to Base-unit via WiFi or via LAN connection to their corporate network.

Stand-Alone Connection

The internal WiFi access Point of MTC-4500B is active . The dongle is paired directly to it. Guest and Staff use the internal WiFi access point of Base-unit to present with all their units. **No Internet access is required.**

The LAN-Port of Base-unit is not connected. The PC-users can present with or without dongle by MTC-4500 PC driver (Windows or MacOS). Android users (BYOD) can share their content by installing the free APP on their device and IOS users can use AirPlay (Apple only).

Recommended Environment

This option is best for temporary operation, small installations, and rooms without network access or networks that do not allow network access for Guests, due to strict security concerns, and are completely separate from the corporate network.

Under this mode, dongle will be automatically paired to the base unit WiFi hotspot when plugging dongle to the base unit USB port for pairing.

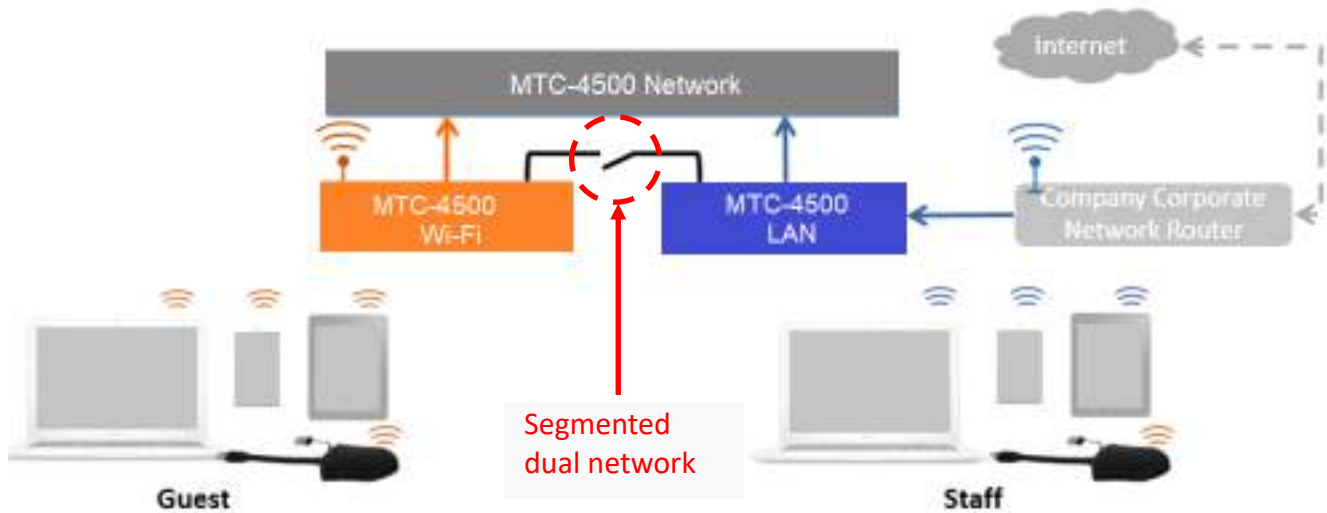

You can start using MTC-4500 in this mode without any other wireless network configuration.

Click "Next step" to configure the network which dongle needs to be paired to.

Set up WiFi access point

Set-up WiFi access point includes, Frequency, Channel, Password.

Wireless network

The screenshot shows the 'Wireless network' configuration interface. At the top, there is a progress bar with four steps: '1. Device name', '2. Mode selection', '3. Network settings', and '4. SSID setting'. The '3. Network settings' step is currently active. Below the progress bar, there are three input fields: 'Frequency' set to '5GHz', 'Channel' set to 'Auto', and 'Password' set to '00005381'. At the bottom, there are two buttons: 'Previous' and 'Next step'.

- **Frequency:** Click to select 2.4 GHz or 5 GHz WiFi frequency. Default is 5 GHz.
- **Channel:** Click to select the WiFi channel. Default is 5 GHz, Auto.

If the WiFi channel is changed, no new pairing of the dongle is necessary.

2.4 GHz frequency band: channels 1, 2, 3, 4, 5, 6, 7, 8, 9, 10, 11,

5 GHz frequency band: no need to choose 5G channel, system will choose proper channel automatically.

Default is 5 GHz, channel: Auto.

Default channel (USA area): 36,40,44,48 or 149,153,157, 161. Four channels will be opened at the same time, system will automatically choose proper channel from them.

Default channel (European area): 36,40,44,48.

Default channel (China): 149,153,157,161.

- **Password:** Click in the input field to fill out the appropriate password with length of **8 characters**.

Click "Next step" to edit or change Guest network SSID and STAFF network SSID. This information will be shown at Home Screen of MTC-4500.



Click "Submit settings" to finish configuration.
After it please re-pairing dongle with the base unit.

6.1.1.3 Wireless Infrastructure mode

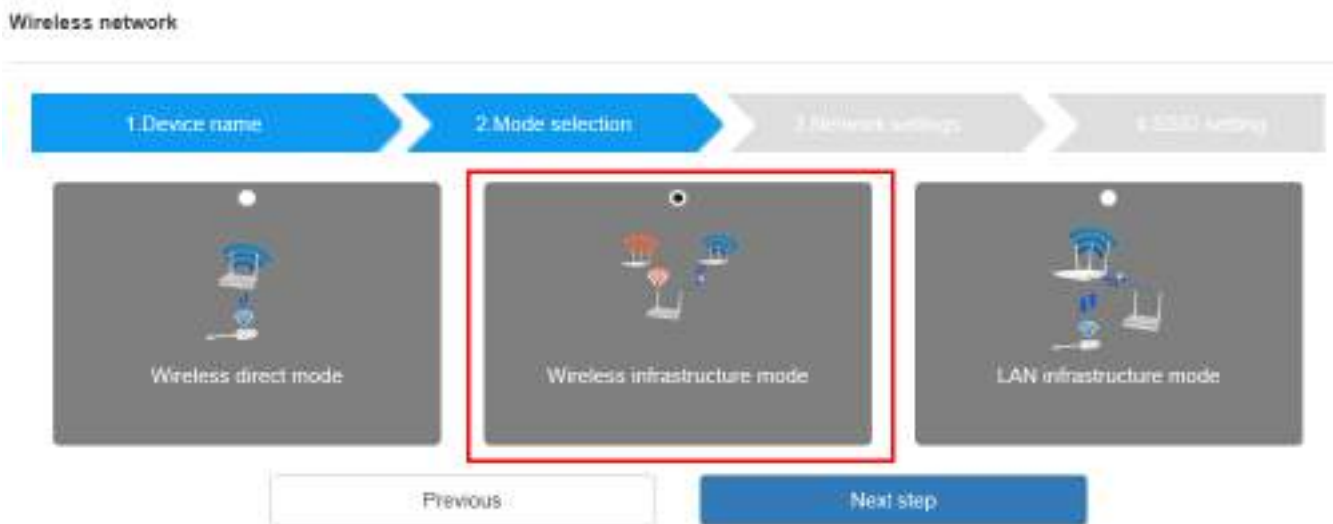

MTC-4500 can connect to a wired and a wireless network simultaneously. The basic unit is firmly "connected to the company network with LAN. Guest users connect to WiFi "Guest" access. The employees ("Staff") connect to their usual access point of the corporate network, without having to change the WiFi. This is very useful for organizations, which have a wireless "Guest" network for external visitors and a wired "Staff" network for their employees. The segmented Dual Network of MTC-4500 provides two separated routing ways to connect to the Base-unit at same time. Guest-users are not able to access any resource on the Ethernet of the company. MTC-4500 uses the existing wireless network infrastructure. Guest and Staff have internet access.

Dual Network Configuration

The internal the WiFi network of MTC-4500 is connected to Guest WiFi network of the organization, (**Client**

Mode: the indicator-icon  shows the actual signal strength). The Base-unit is still wired with LAN-cable to the internal company network
 The PC-users can present, with or without dongle TOUCH by MTC-4500 PC driver (Windows or MacOS).
 Android users can share their content by installing the free APP, IOS users can use AirPlay to share content (Apple only).

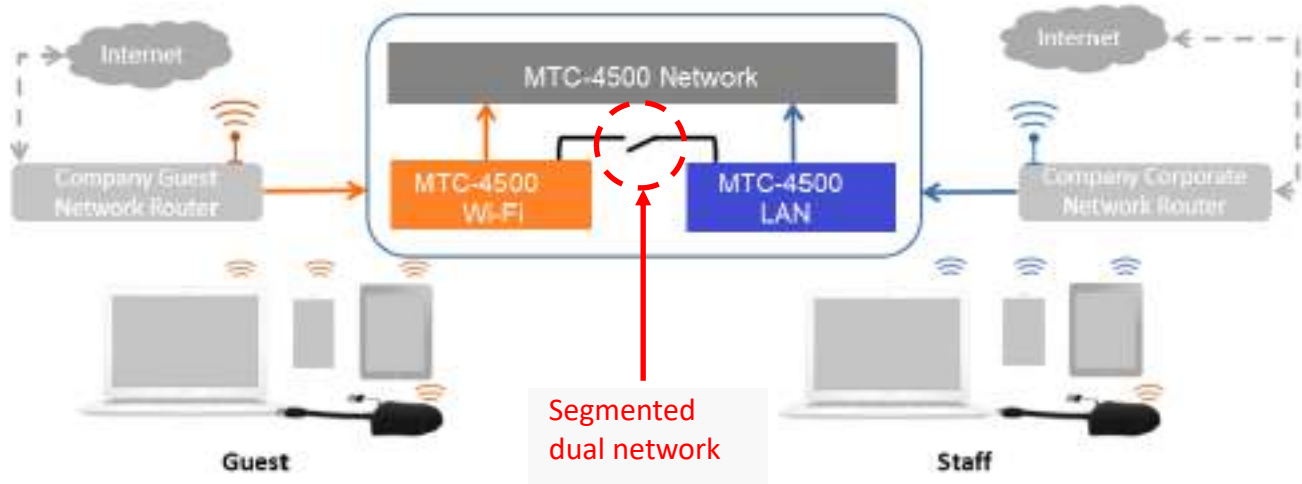

The dongle is connected to the WiFi access Point of Guest network, which in turn is connected to the internal WiFi access Point of MTC-4500. (The dongle can also be configured to connect to the enterprise’s access point.)
 Mobile users stay connected to their current network, have access to their normal corporate environment, as well as Internet access.

The actual received signal strength from Guest network is shown in Home screen of MTC-4500: .

Follow the instructions of the configuration wizard for “Wireless infrastructure mode”. When pairing the dongles, by plugging the dongle in the USB port of the Base-unit, it will automatically pair to the associated access point of Guest or Staff WiFi and NOT to MTC-4500.

Click “**Next step**” to configure the network which dongle needs to be paired to.

“Dongle connects to base unit via wireless network.”

Choose a wireless network which is separate from the company LAN network for guest users.

Select SSID: Choose a wireless network to connect to base unit for guest.

Password: enter password to connect the base unit to the guest network.

Wireless network

1 Device name 2 Mode selection 3 Network settings 4 SSID setting

5GHz ONLY

Select SSID: MTC_Guest_5.DG (SignalLevel:59%) Rescan List ✓

Password: ***** ✓

Previous Next step

Click "Next step" to edit or change Guest network SSID and Staff network SSID.

Wireless network

1 Device name 2 Mode selection 3 Network settings 4 SSID setting

GUEST network SSID: MTC-4500

STAFF network SSID: Staff SSID

Previous Submit settings

WiFi name of guest and staff will be shown on home screen after "Submit settings".



After submitting successfully, please re-pair dongle with base unit.

"Dongle connects to base unit via LAN."

Choose a LAN network which is used for the company staff users.

Note: usually in this mode, dongle paired for internal staff usage.

Select SSID: Choose a wireless network to connect to base unit for guest.

Password: enter password to connect the base unit to the guest network.

Select dongle SSID: choose the same LAN network which base unit connects, to pair the dongle.

Password: enter password of the LAN network.

See picture as below:

Wireless network

1 Device name 2 Mode selection 3 Network settings 4 SSID setting

Dongle connects to base unit via wireless network

Dongle connects to base unit via LAN

5GHz ONLY

Select SSID: MTC_Guest_5.0G (SignalLevel:59%) Rescan List ✓

Password: ✓

Select dongle SSID: MTC_5.0G (SignalLevel:99%) Rescan List ✓

密码: ✓

Previous Next step

Click "Next step" to edit or change Guest network SSID and Staff network SSID.

Wireless network

1 Device name 2 Mode selection 3 Network settings 4 SSID setting

GUEST network SSID: MTC-4500

STAFF network SSID: Staff SSID

Previous Submit settings

WiFi name of guest and staff will be shown on home screen after "Submit settings"

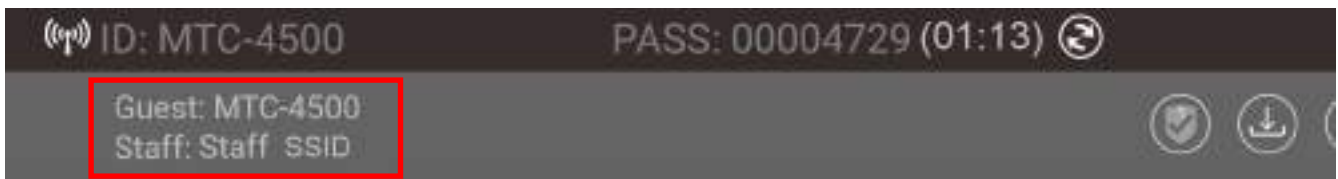

After submitting successfully, please re-pair dongle with base unit.

6.1.1.4 LAN Infrastructure Mode



In this configuration the **built-in WiFi** access point of MTC-4500 **is disabled:** .

The dongle and/or the mobile devices can connect to the secured wireless access point of the company network. The Base-unit of MTC-4500 is hard-wired connected via LAN to the Ethernet of the Company network.

The Staff-users connect to their usual access point of Company network, without the need to change the WiFi. Follow the instructions of the configuration wizard for "LAN infrastructure mode".

When pairing the dongles, by plugging the dongle in the USB /Type C port of the Base-unit, will be automatically paired to the Staff access point, and NOT to "MTC-4500" Base-unit.

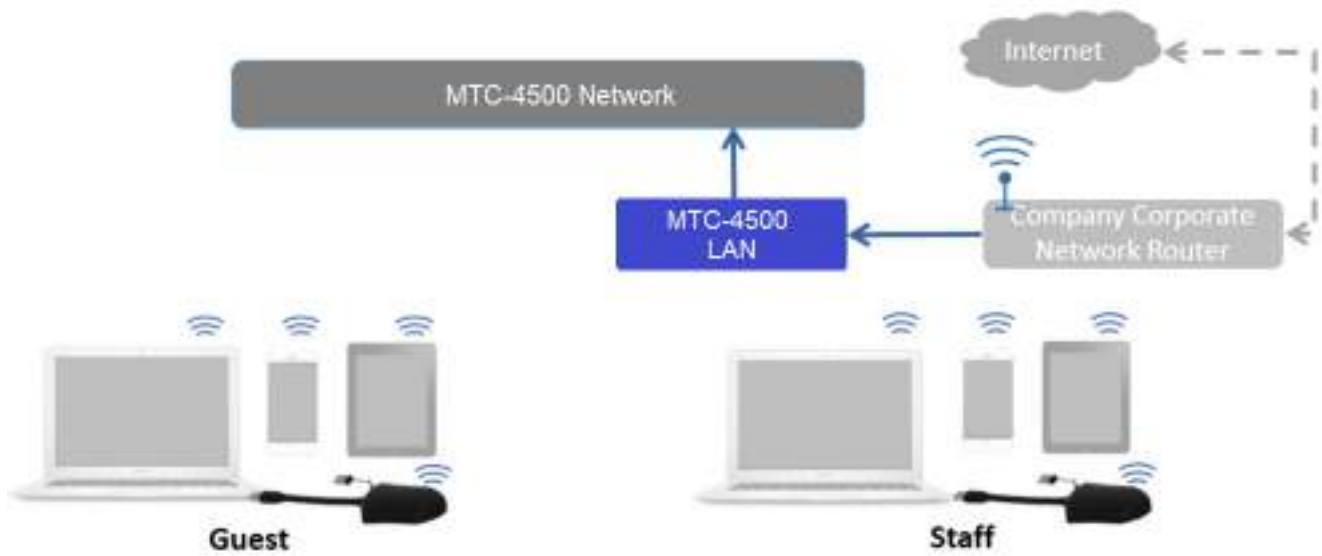

Click "Next step" to choose a LAN network which is used for the company staff users and pair the dongle into this network.

Wireless network

The screenshot shows a configuration interface with a progress bar at the top containing four steps: 1. Device name, 2. Mode selection, 3. Network settings (highlighted in blue), and 4. SSID setting. Below the progress bar, there is a checkbox for '5GHz ONLY' which is checked. Under 'Select Sid', a dropdown menu shows 'MTC_5.0G (SignalLevel:99%)' with a 'Refresh List' button and a green checkmark. Below that is a 'Password' field with a masked password '*****' and a green checkmark. At the bottom, there are 'Previous' and 'Next step' buttons.

Click "Next step" to edit or change Guest network SSID and Staff network SSID.

Wireless network

The screenshot shows the same configuration interface with the progress bar now highlighting step 4: SSID setting. Below the progress bar, there are two input fields: 'GUEST network SSID' with the value 'MTC-4500' and 'STAFF network SSID' with the value 'Staff SSID'. At the bottom, there are 'Previous' and 'Submit settings' buttons.

WiFi name of guest and staff will be shown on home screen after "Submit settings"



After submitting successfully, please re-pair dongle with base unit.

6.1.2 Ethernet

Configure the Ethernet settings. MTC-4500B has 2 LAN ports, if the base unit is connected with 2 LAN cable, you can configure from below tab.

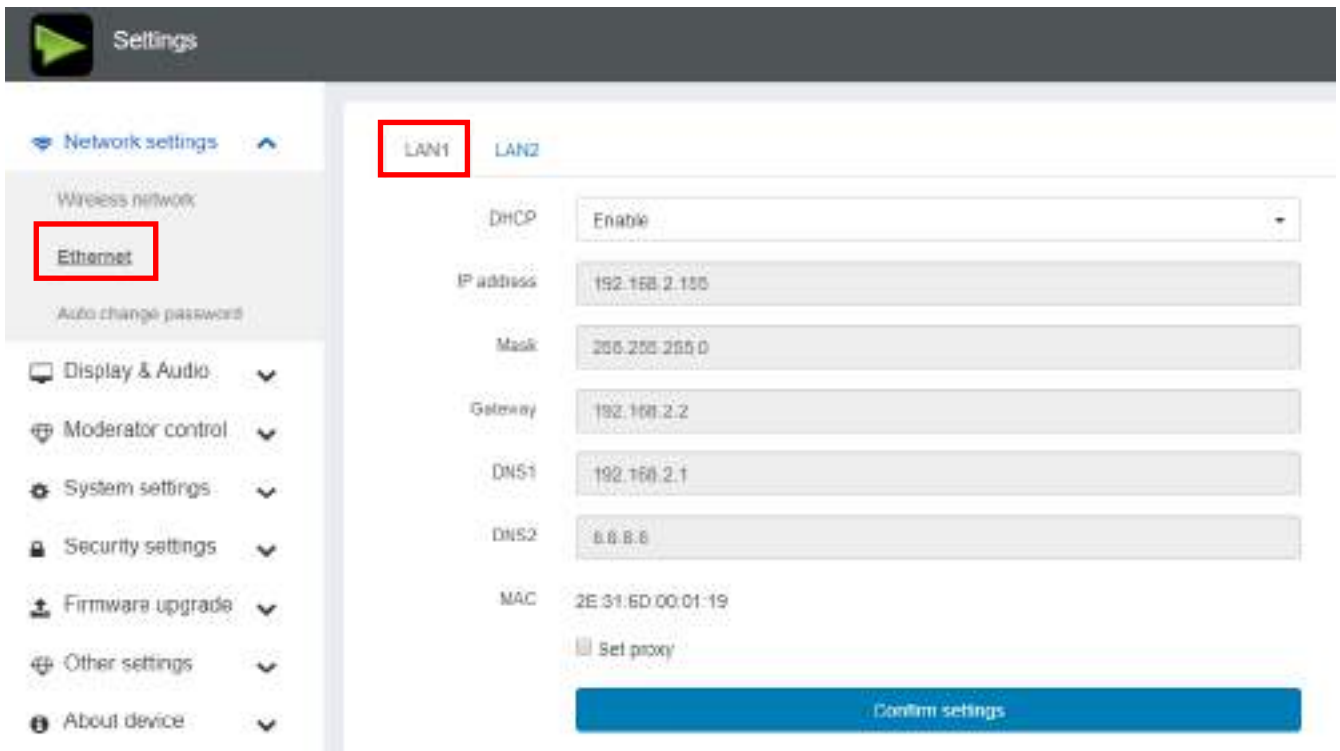

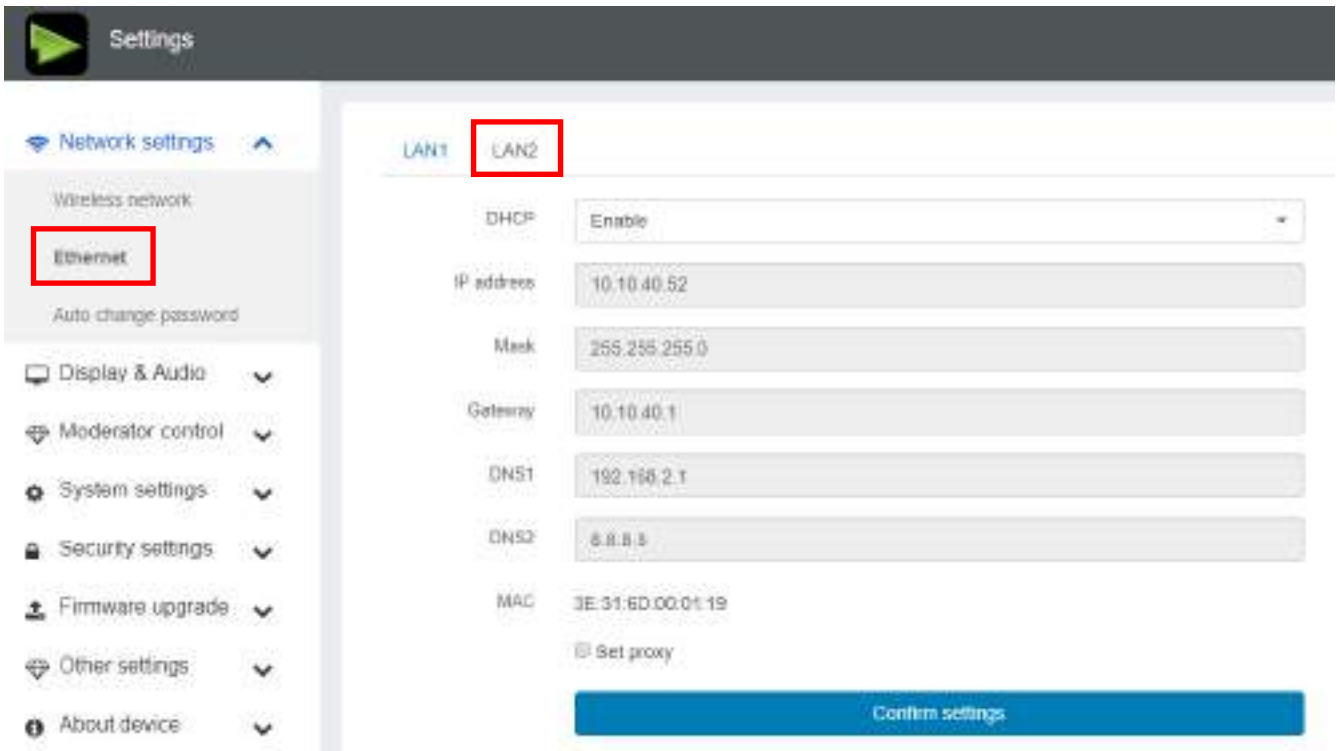

6.1.3 Auto change password

The password remains unchanged for all participants of the meeting, while at least one dongle **or** a WiFi network of a mobile device are connected with Base-unit. After the user is disconnected, a configurable time runs.

- The changeable password will be fixed by connecting a dongle to PC/Laptop or connect a mobile unit to the WiFi of the Base-unit, and continue to be changeable after 15s after disconnecting the last dongle or disconnect the WiFi of a mobile unit.
- User do not need to re-pair the dongle again, if only the password is changed. A **Smart mobile device** has to enter the correct SSID and password to connect to the Base-unit access point, in order to access all functionality.

Configure to automatically change WiFi password to a random number every period of time.

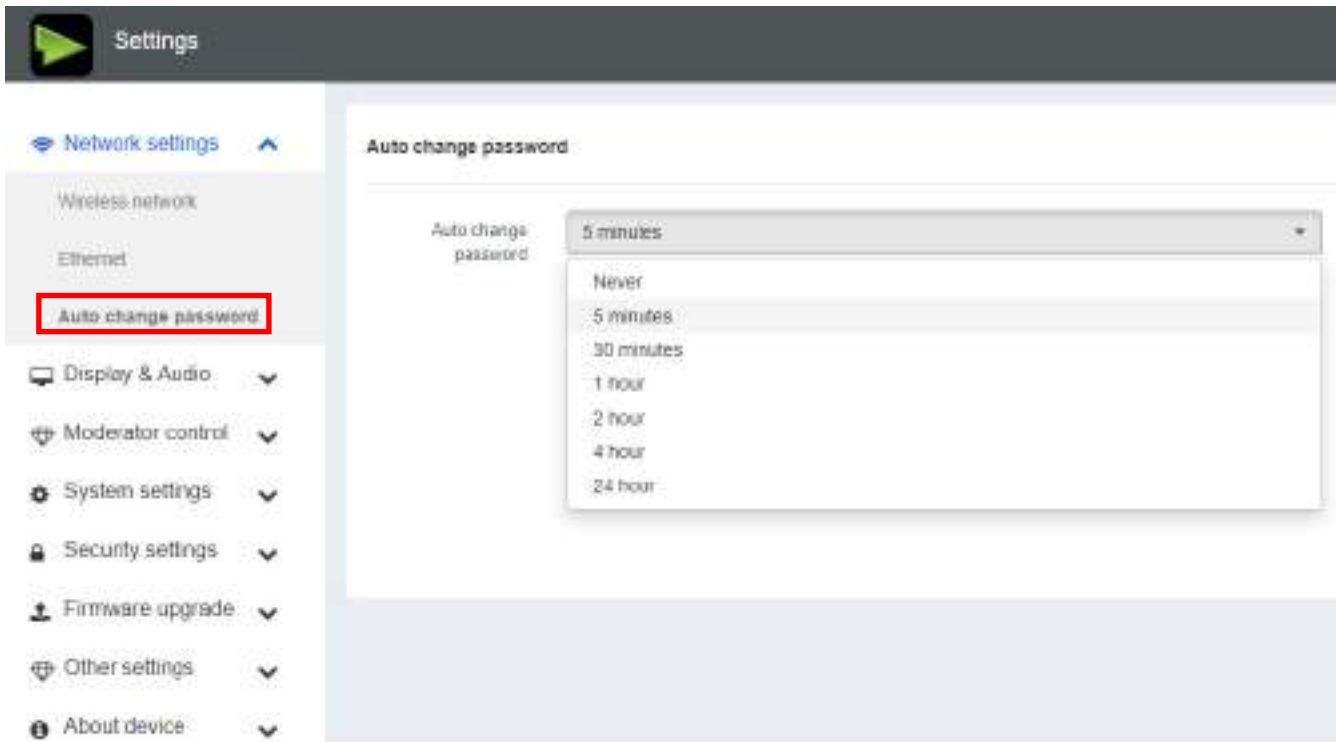

Click to set the configuration, including

- **Never:** never change WiFi password. (Even after POWER-OFF condition)
- **5 minutes:** change WiFi password every 5 minutes.
- **30 minutes:** change WiFi password every 30 minutes.
- **1 hour:** change WiFi password every 1 hour.
- **2 hours:** change WiFi password every 2 hours.
- **4 hours:** change WiFi password every 4 hours.
- **24 hours:** change WiFi password every 24 hours.
-

6.2 Display & Audio

6.2.1 HDMI

HDMI Resolution

Select the resolution at HDMI output of Base-unit.

Existing HDMI output resolution as below:

- Auto
- 3840x2160 @30Hz
- 3840x2160 @60Hz
- 3840x2160 @50Hz
- 1920x1080 @60Hz

- 1920x1080 @50Hz
- 1920x1080 @30Hz

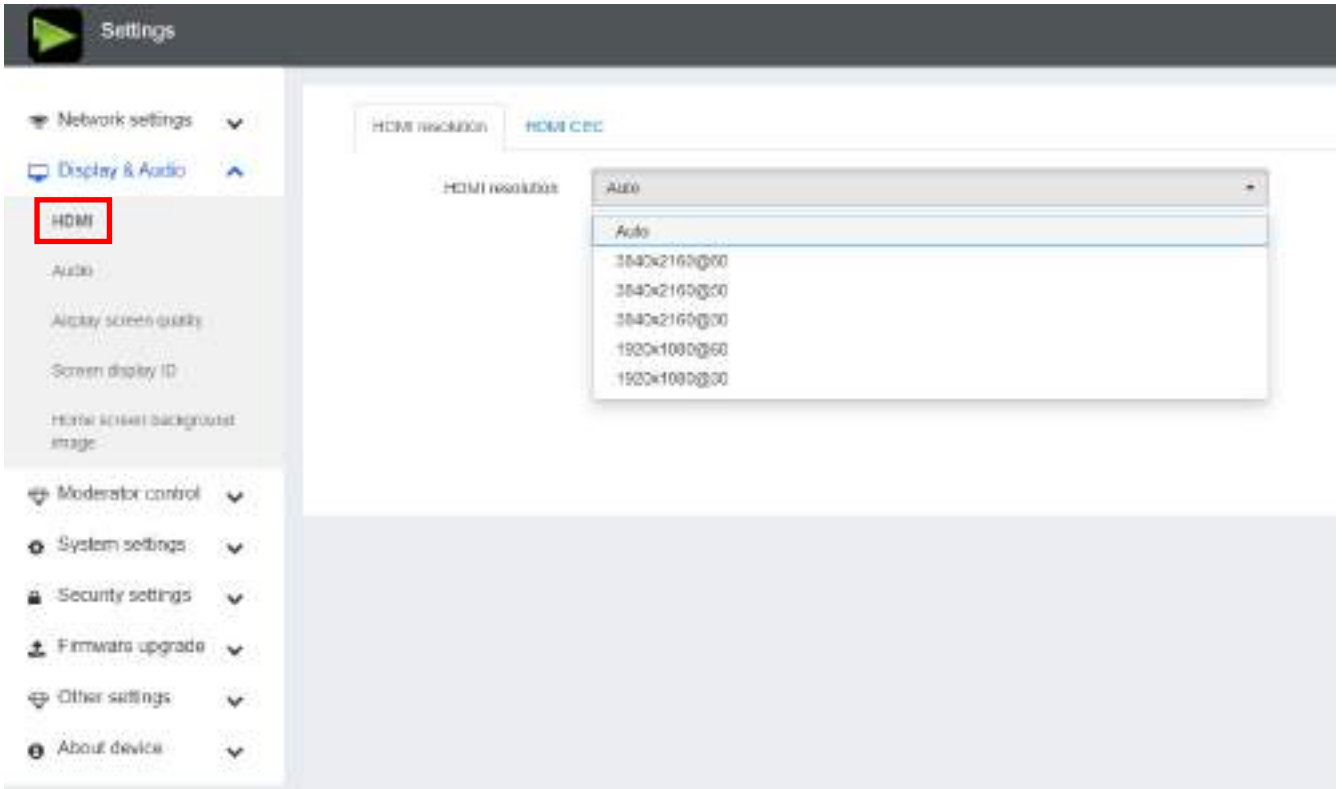

Note: if the display is only support FULL HD, the 4K resolution will not be shown on the list of the below resolution.

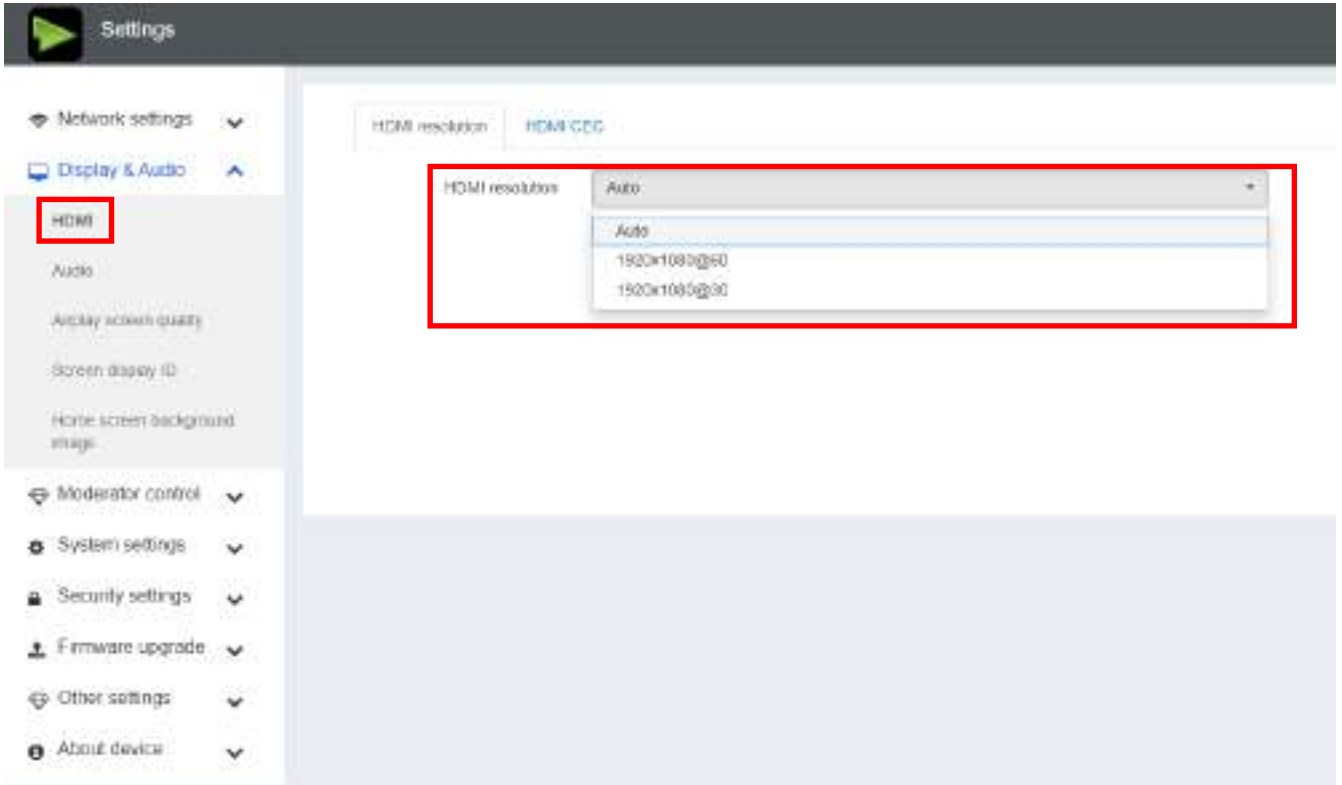

HDMI CEC

Base unit support CEC function if the connected display support CEC function.

- **Device auto power off:**
 - ON (Default): Display will automatically turn off when base unit is powered off.
 - OFF: Display will not automatically turn off when base unit is powered off.
- **Base unit auto power on:**
 - On: Base unit will be automatically wake up when display is on.
 - Off (Default): Base unit will not be automatically wake up when display is on.

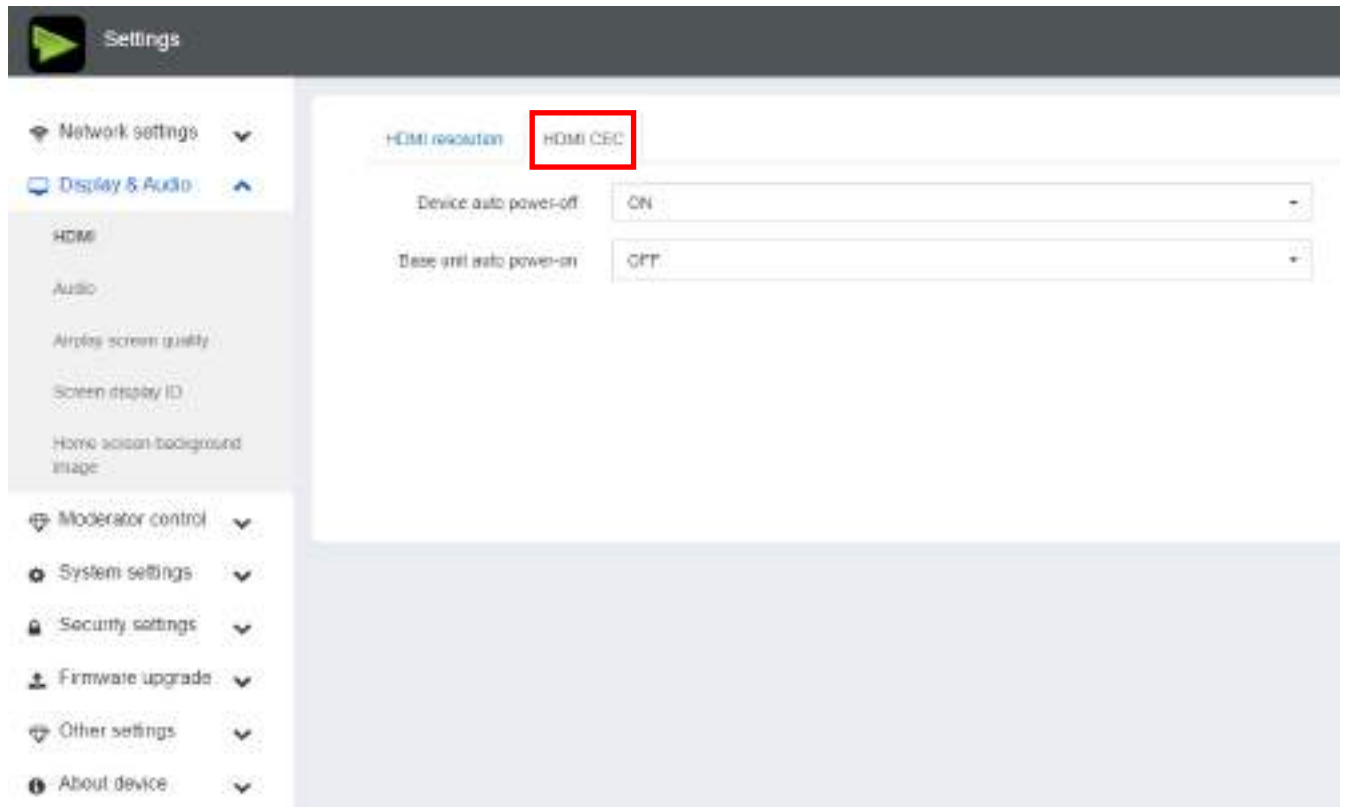

6.2.2 Audio

Audio

Choose audio output:

Jack: output only 3.5mm mini-jack audio.

HDMI: output only HDMI audio.

Jack&HDMI (Default): output Jack & HDMI audio

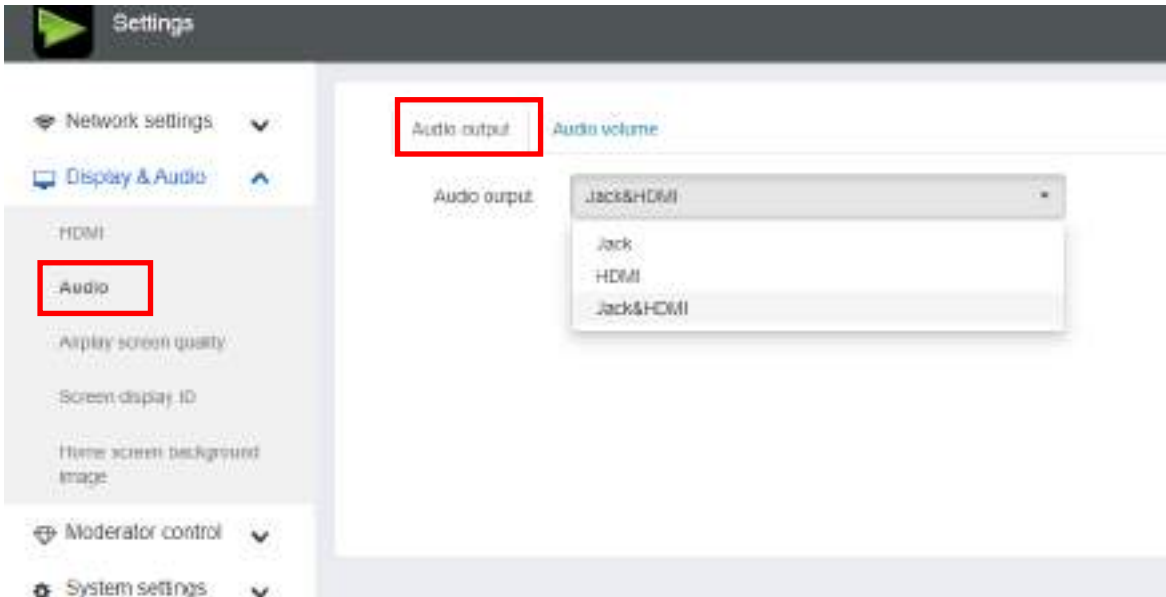

Volume

User can select volume of display from 0 to 100.

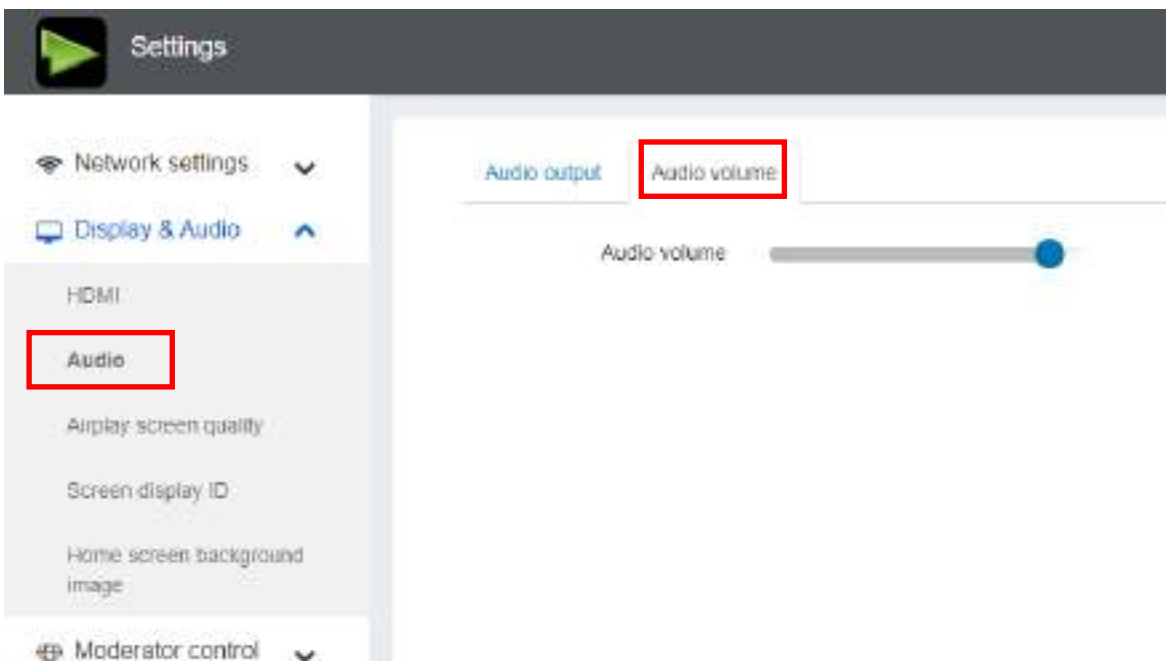

6.2.3 AirPlay screen quality

Click to select the image quality when transmit apple device by "AirPlay" mode.

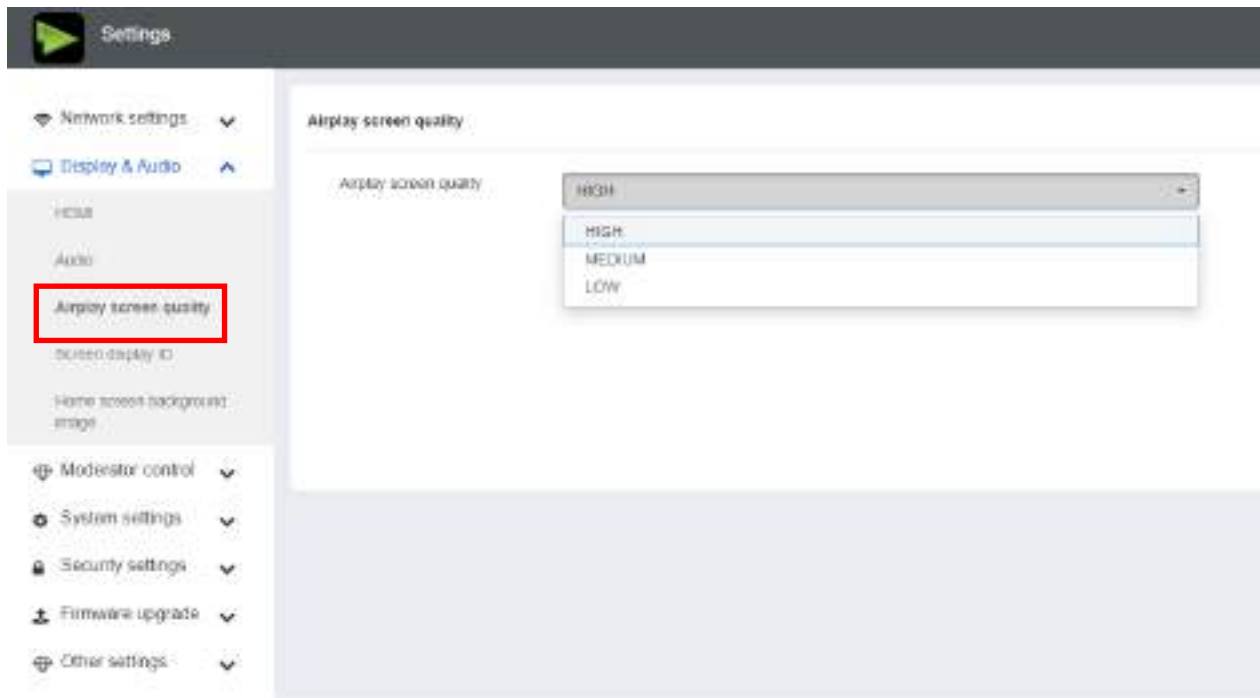

6.2.4 Screen display ID

- **Show device name and password when mirroring:** Name (ID) and WiFi-password can be shown or hided at top status-line of **main screen**.

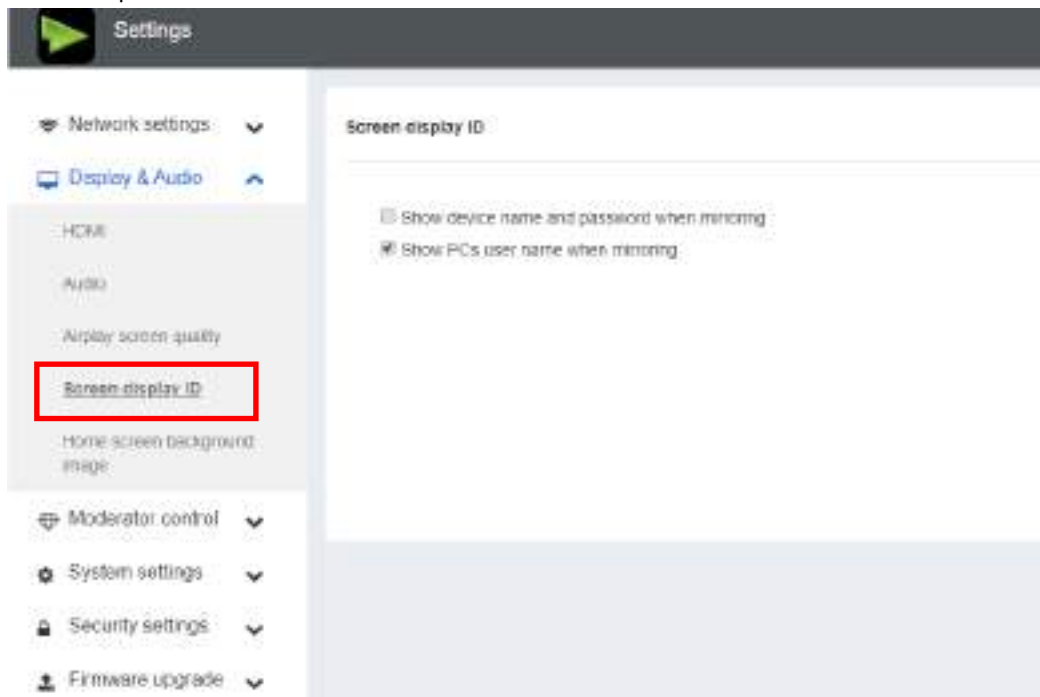

- **Show PCs user name when mirroring.**

Show user name.



6.2.5 Home Screen background image

When powering MTC-4500 the start screen will be displayed. User can change background image of Home screen. Select the image (jpg, bmp, png, gif with resolution 1920x1080 p.) from suitable directory and activate box for selection. You can return to Standard Home screen every time.



6.3 Moderator control

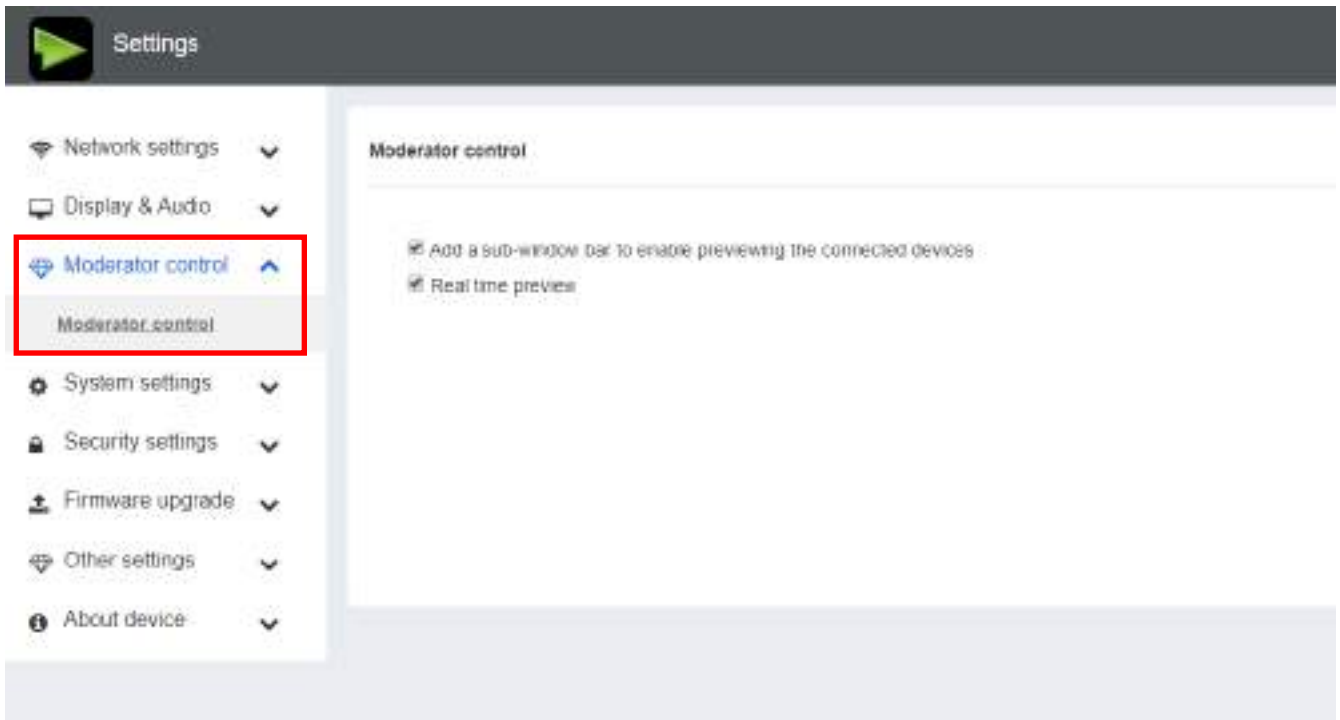

- Add a sub-window bar to enable previewing the connected devices. Tick the icon, it will show the sub window as below once devices are connected to base unit.

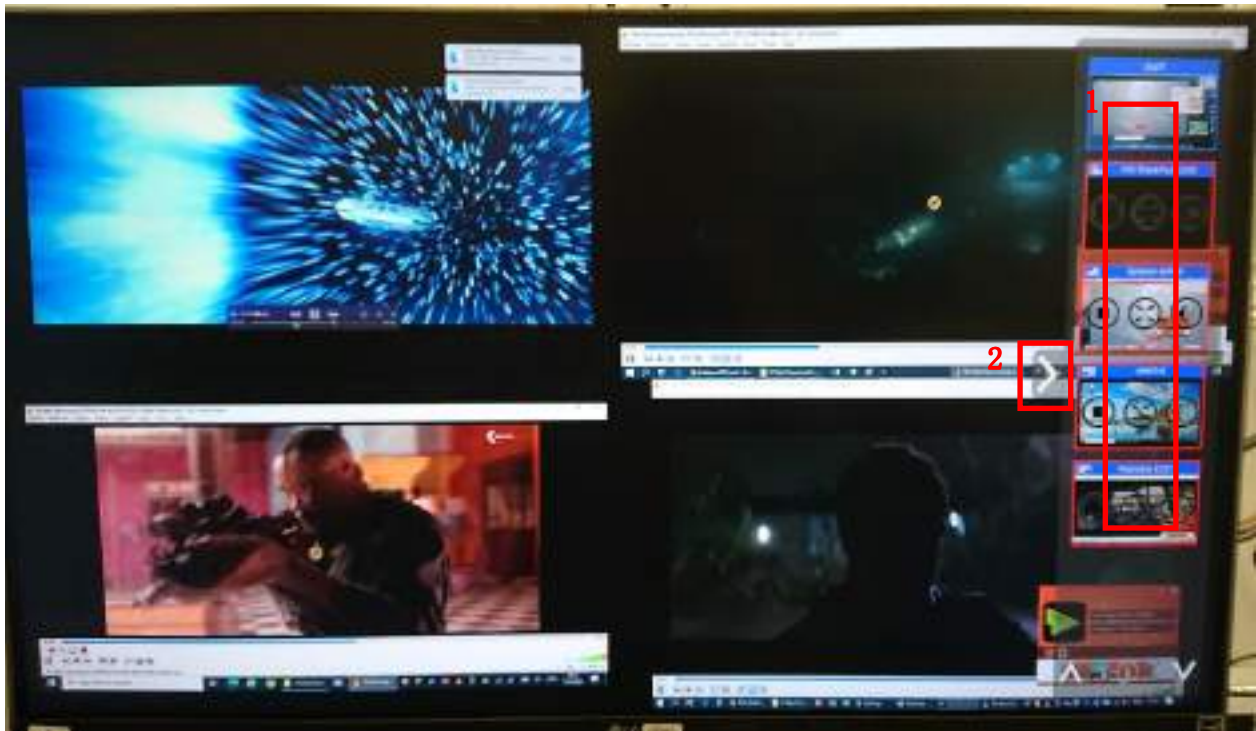

If do not tick the icon, the preview window bar will be minimized as below.

The screenshot shows the MTC-4500 interface with the following details:

- Header:** ID: MTC-4500, PASS: 00004729 (01:13), WiFi IP: 192.168.43.1, Lan IP: 10.10.40.52/NA.
- Guest/Staff:** Guest: MTC-4500, Staff: Staff SSID.
- Time:** 10:04.
- PC Section:**
 - Step 1: Execute MTC-4000 program from USB stick or connect to WiFi SSID with PASSWORD or LAN. Use browser to access WiFi IP or LAN IP to download the file to execute.
 - Step 2: Plug the dongle into computer. MTC-4000 launcher software runs automatically.
 - Step 3: Wait till dongle LED indicator turn static green, then tap button to mirror the screen.
- Android/iOS Section:**
 - Step 1: Download app from Google Play.
 - Step 2: Connect wireless network SSID with PASSWORD or LAN.
 - Step 3: Launch the app and click Mirroring to show your mobile screen.

- Real time preview

If tick the icon, the preview window will show real time preview, if not tick, the preview window will only show a static picture as below.



6.4 System settings

6.4.1 Buttons:

Show Device name, MAC Address, Serial Number, Device Version, Device Status, Last Action, Item Operate.

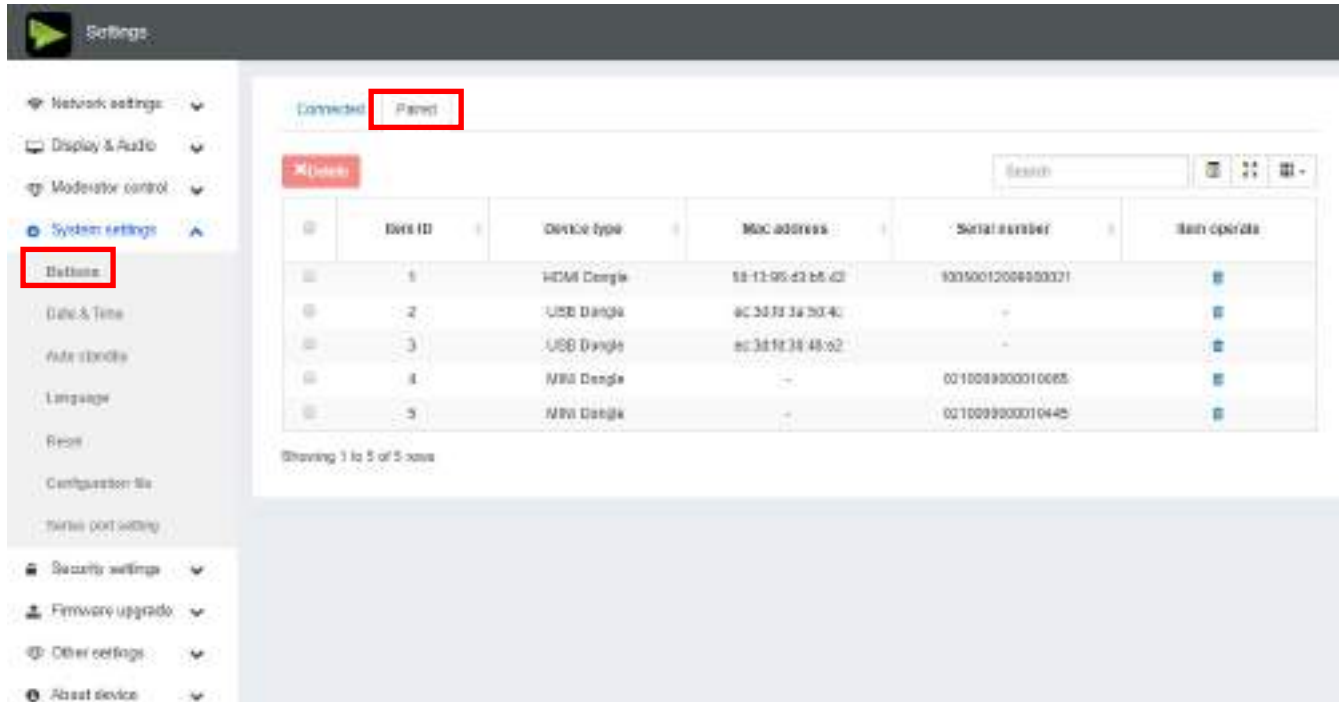

Paired: Show properties of connected dongles and can be managed from this page.

6.4.2 Date & Time

Includes Automatic date & time, Set date, Set time, Select time zone.

- **Automatic date & time:** Check to use a NTP time server to provide time as system time.
- **Set date:** Click in the input field to fill out the appropriate date.
- **Set time:** Click in the input field to fill out the appropriate time manually. The setting is **not** saved, when power is off.
- **Select time zone:** Click in the input field to fill out the appropriate time zone.

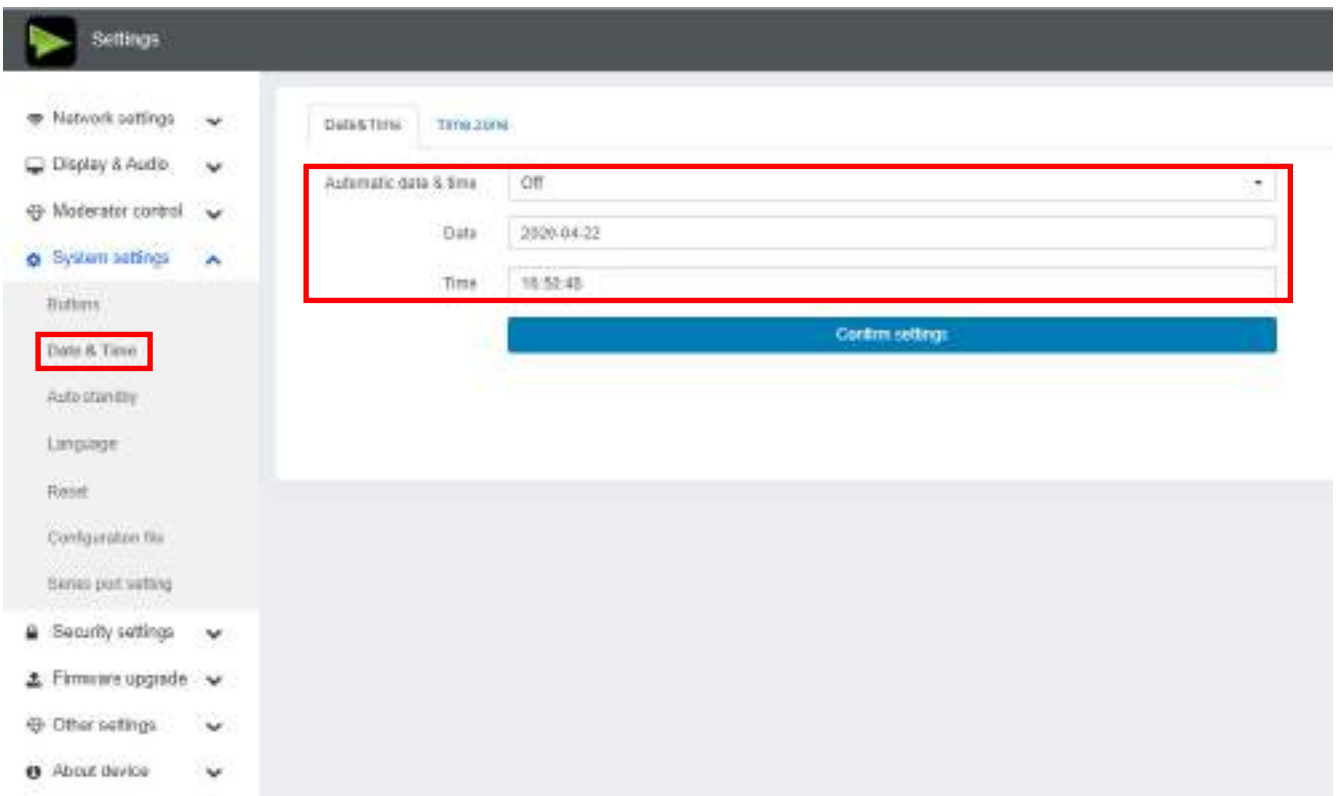
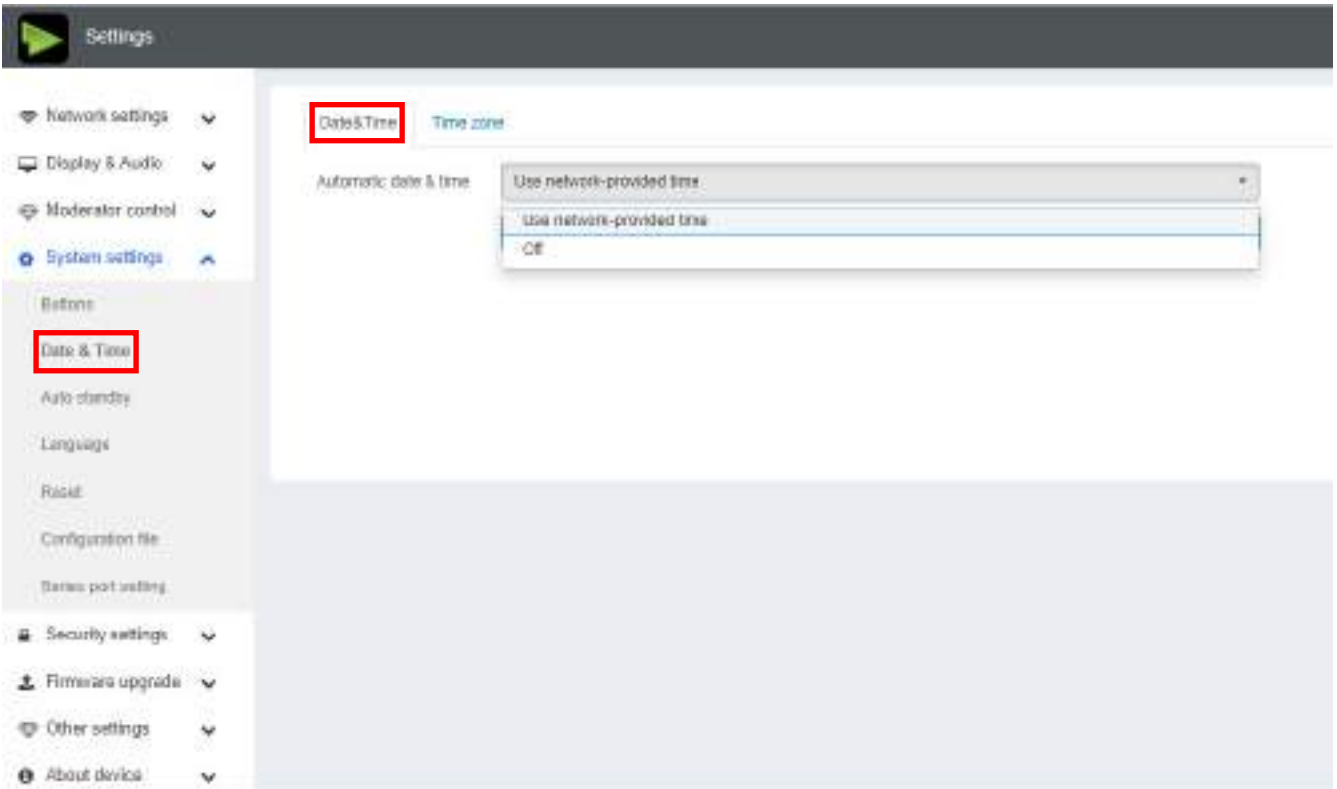

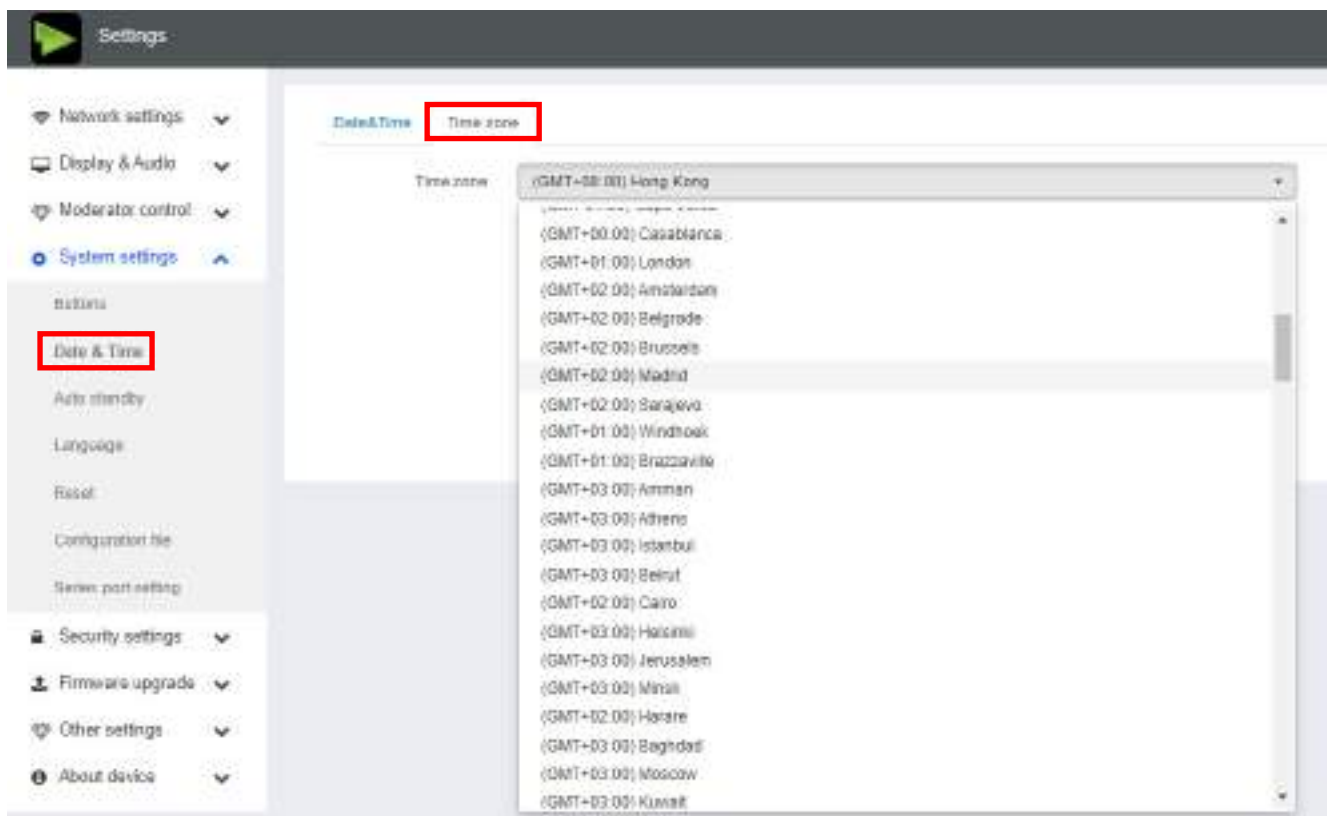

6.4.3 Auto standby

If the Auto Standby mode is activated, MTC-4500 will automatically switch to power saving mode, a selectable time after the last dongle was plugged out, or WiFi of a mobile unit was disconnected, or there is no operation at the system. Time is selectable from **Never** to **30 minutes**. In Standby green LED in top of Base-unit is flashing and **HDMI-output is switched off**.

When a **dongle is plugged in and connected**, or a **mobile unit is connected**, Standby is deactivated.

Movement of mouse at USB-input at Base-unit deactivates Standby mode also.

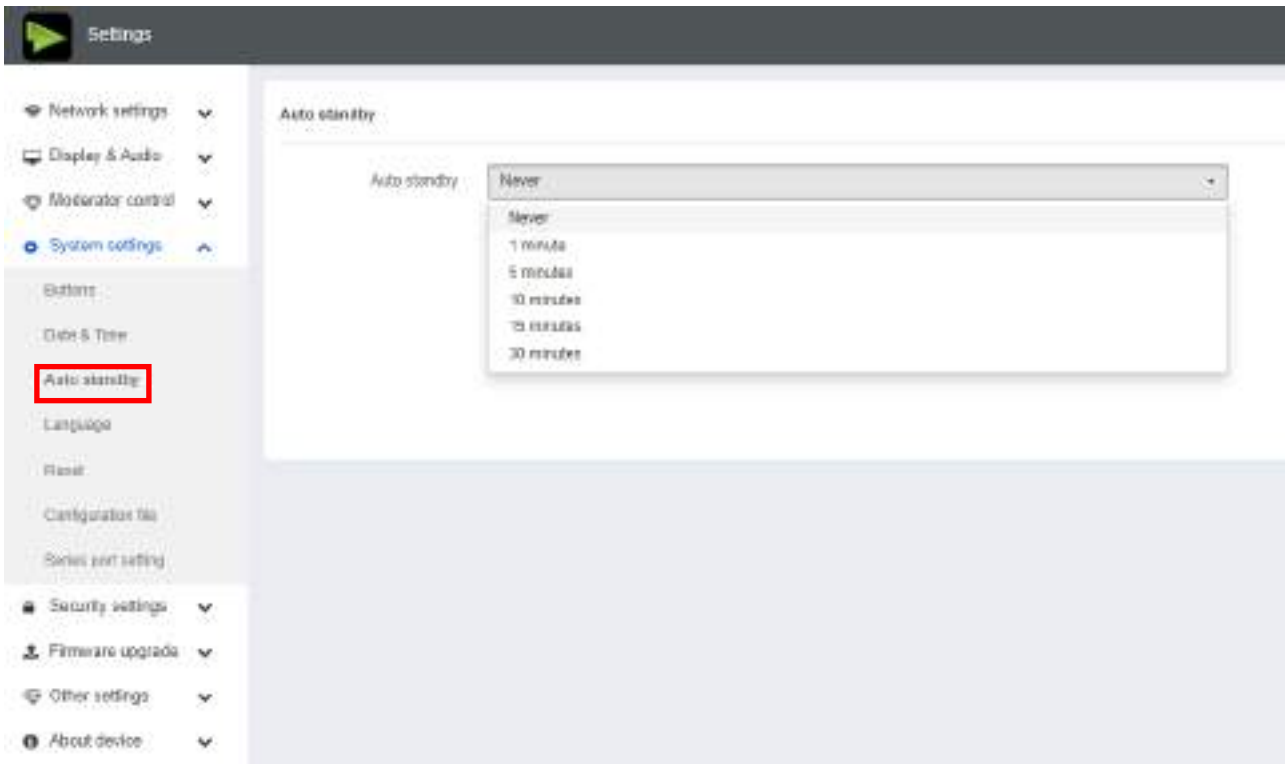

6.4.4 Language

Select an installed display language.

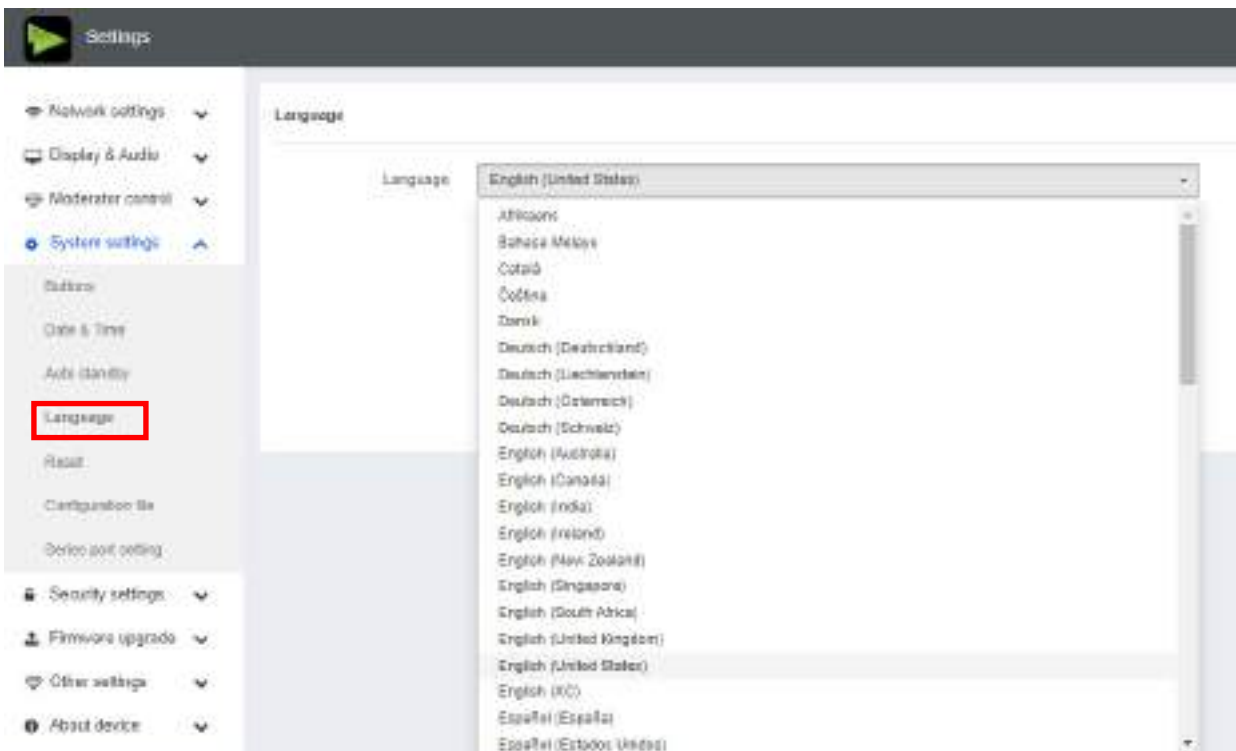

6.4.5 Reset

Doing factory reset to restore unit.

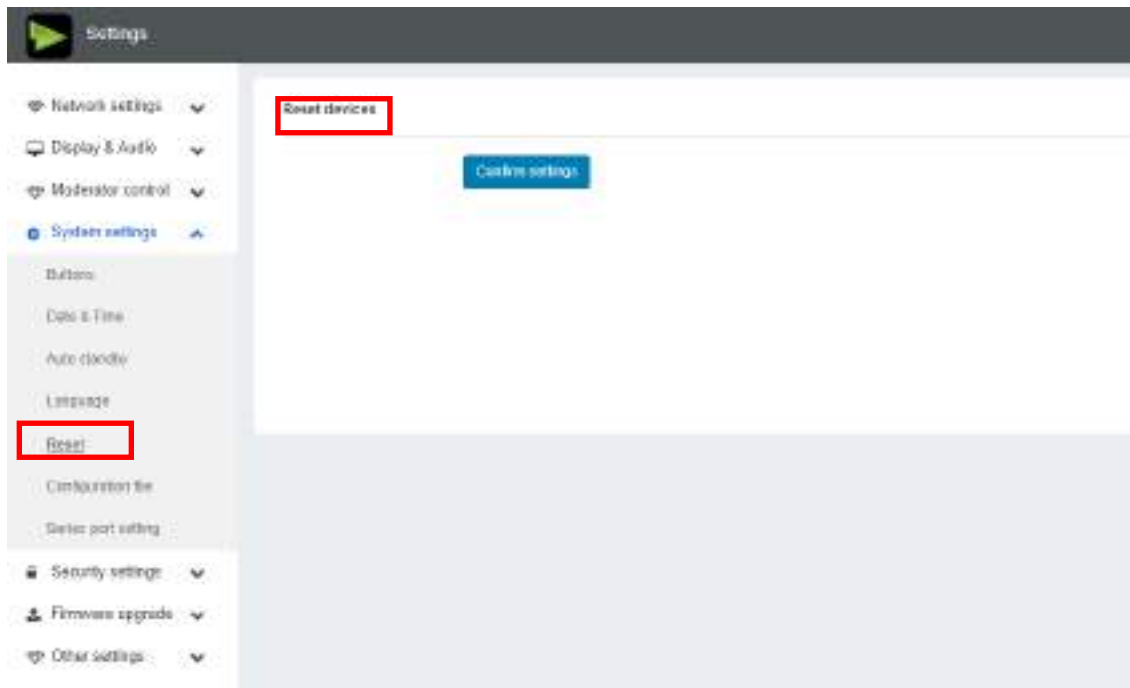

6.4.6 Configuration File

Configuration File is a packaged file which contains all the configuration parameter of MTC-4500B, which could be downloaded and copied to multiple device which needs to use the same configuration.

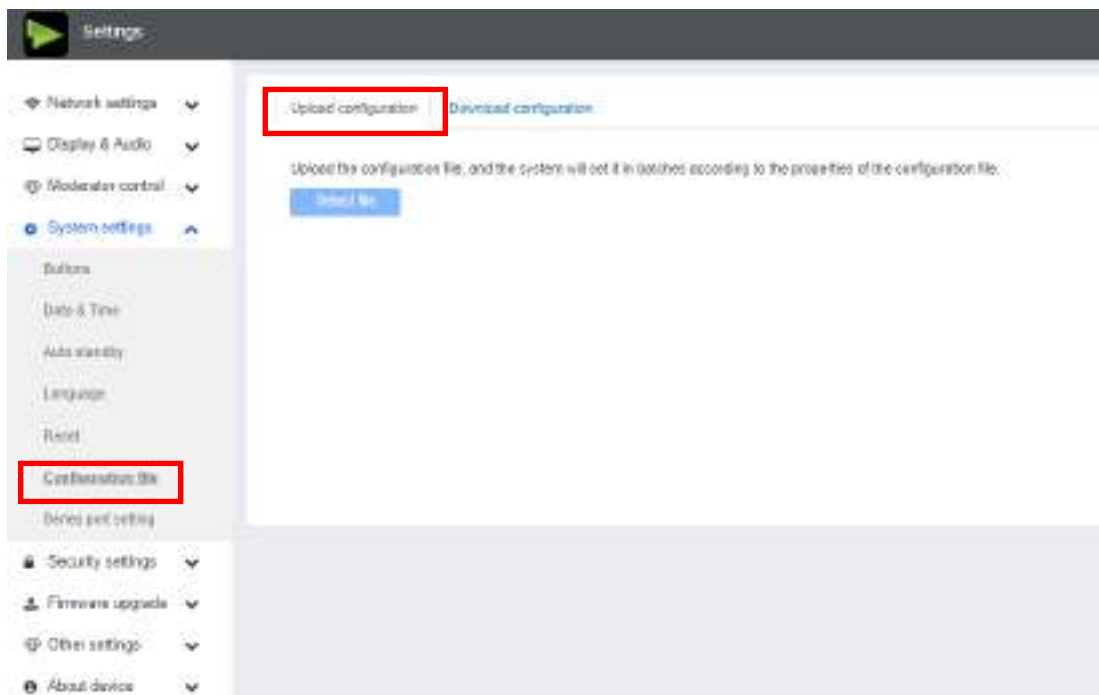

6.4.7 Series Port Setting

To configure telnet command and RS-232 command.

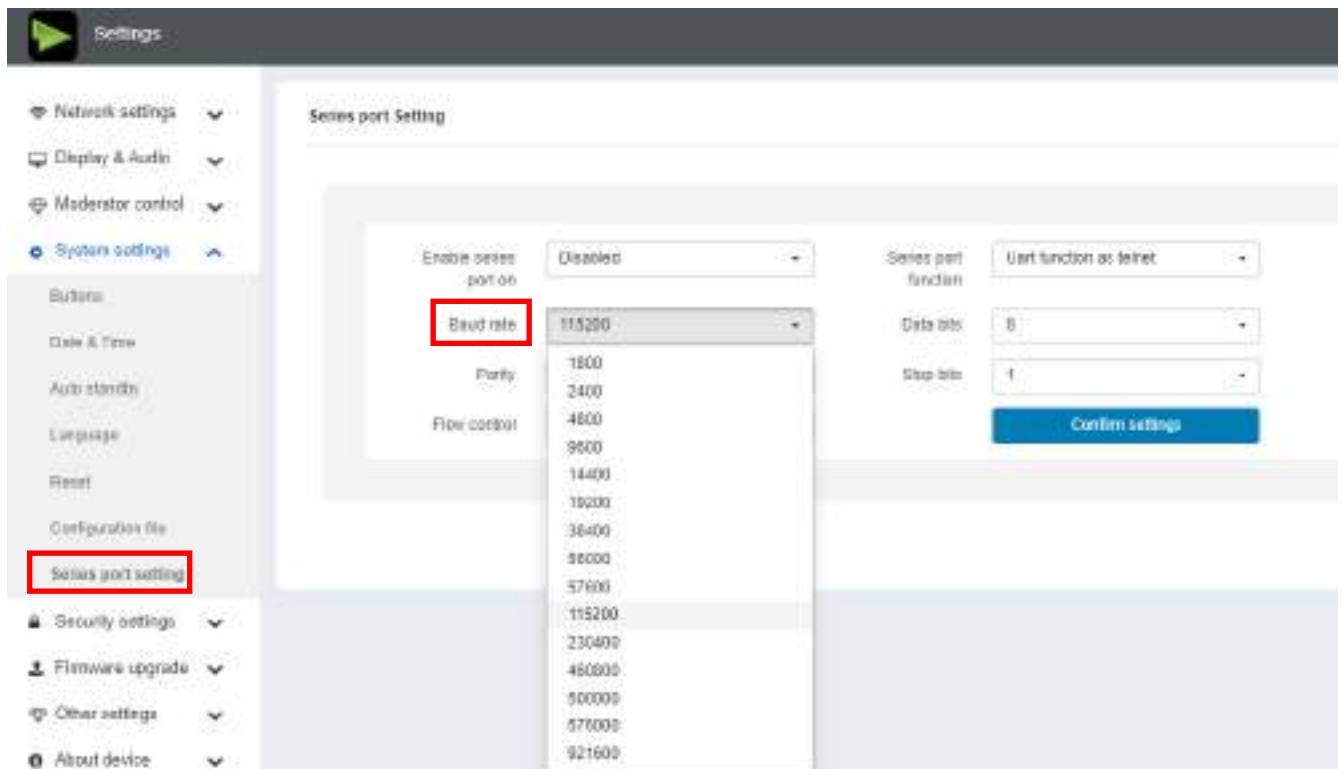
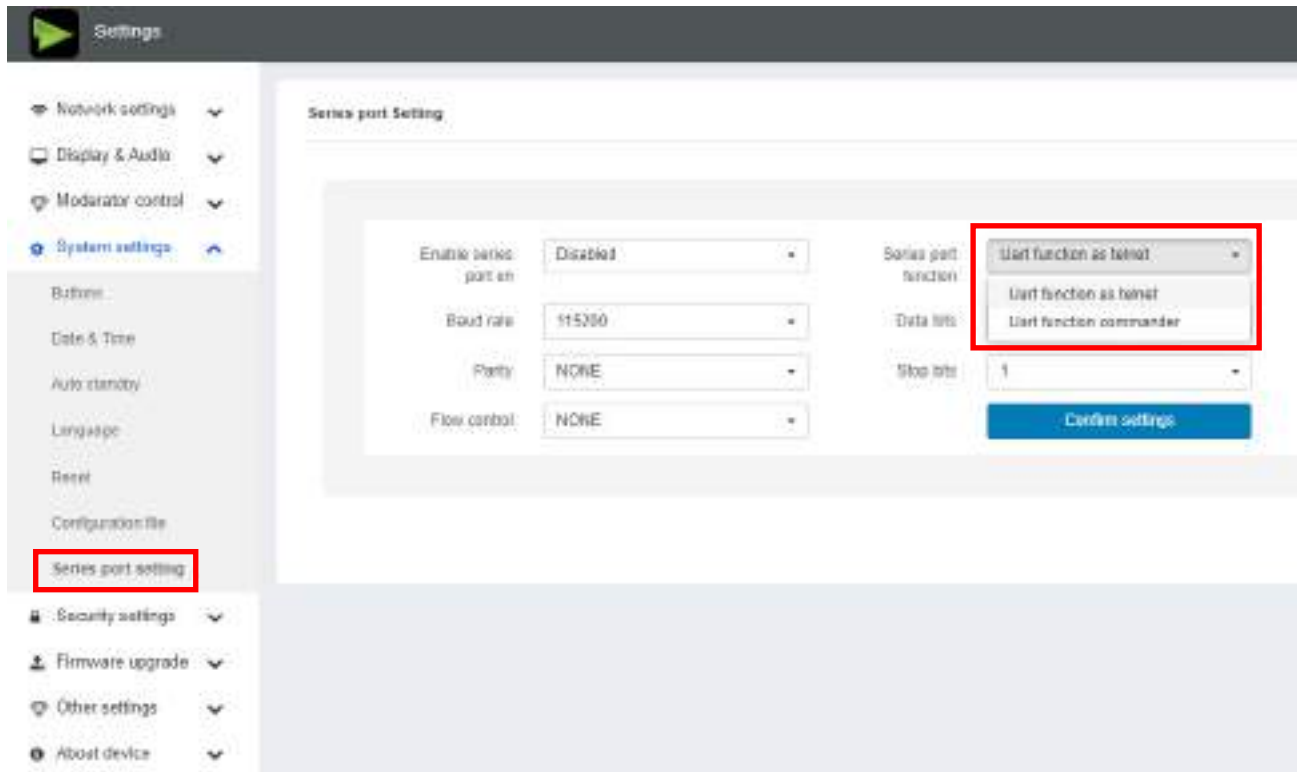

6.5 Security Settings

6.5.1 Security level

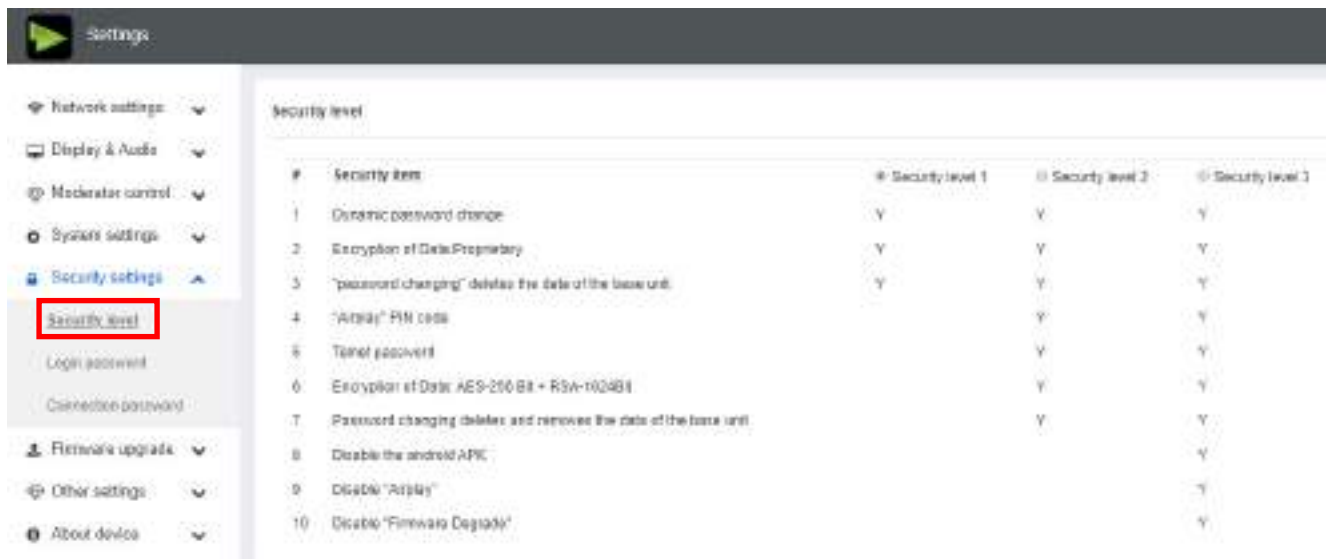

Based on user requirements, **three different security levels** can be set in the menu of MTC-4500, to satisfy different security requirements, according to different security sensitive environments or security policies. A security level is a predefined set of settings. Click on the corresponding entry in the menu if you want to adjust the respective security features. The default setting is level 1.

Level 1: normal safety; keeps the security in normal and daily usage for any organization, such like classroom, regular meeting room etc.

Level 2: higher security; provides increased security for companies, organizations, government agencies, etc., through powerful encryption of audio and video data; other security features include limiting the transmission of "AirPlay" by introducing a password.

Level 3: is used for strict security requirements of companies, organizations, authorities, banks. This level contains all "Level 2" security measures; in addition, all mobile applications, such as the Android APP as well as AirPlay are blocked, the web browser (WebUI) of the Base-unit is blocked. In addition, the downgrade of the firmware is not possible.

The setting of the security level is displayed in the Home screen, click the icon  for more information.

6.5.2 Login Password

Change admin password for entering setting menu on webserver. Default password, or after a RESET, is "admin". You can change the password as you like. You can also deactivate the password entry, set the appropriate checkmark and "Confirm settings".

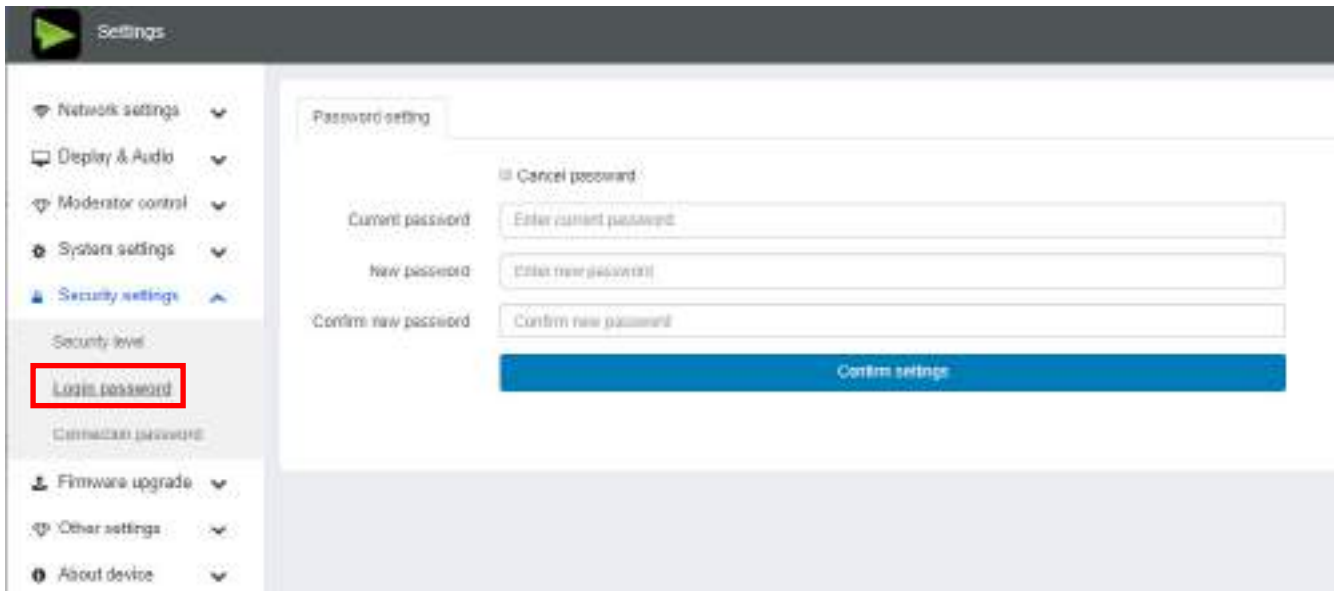

6.5.3 Connection password

Two type of password format can be chosen to show on home screen.

- 4-digits password, beginning with 0000
- 8-digits password

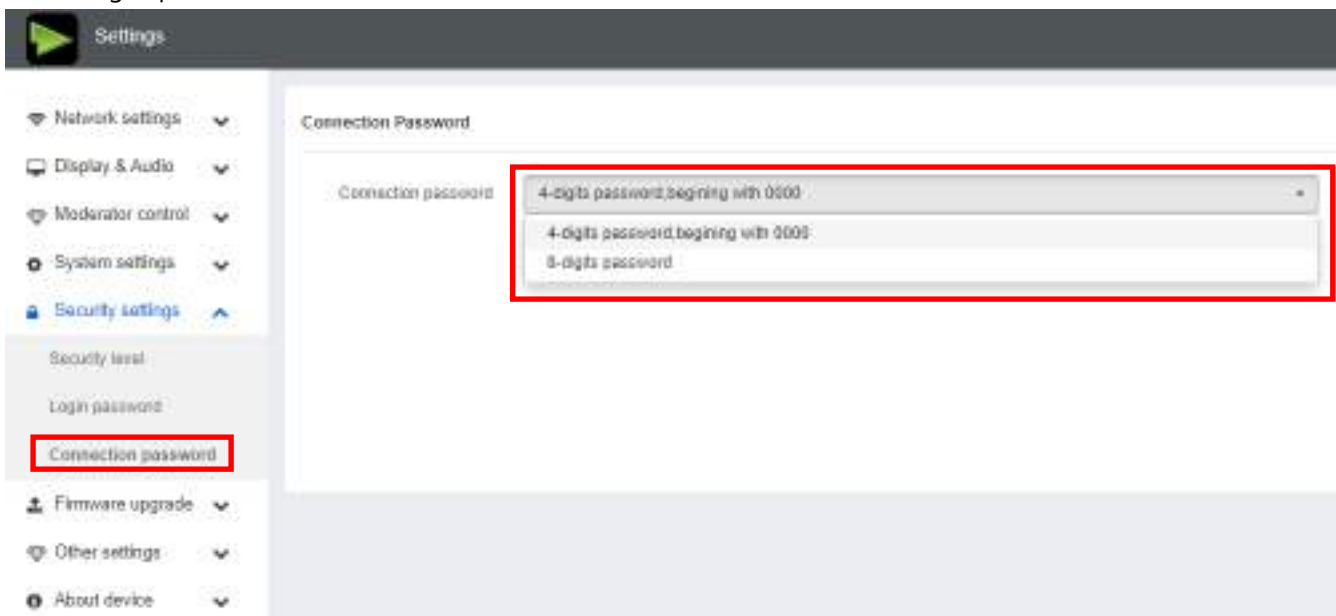

6.6 Firmware upgrade

6.6.1 Firmware Update

To upload local updating files to upgrade base unit.

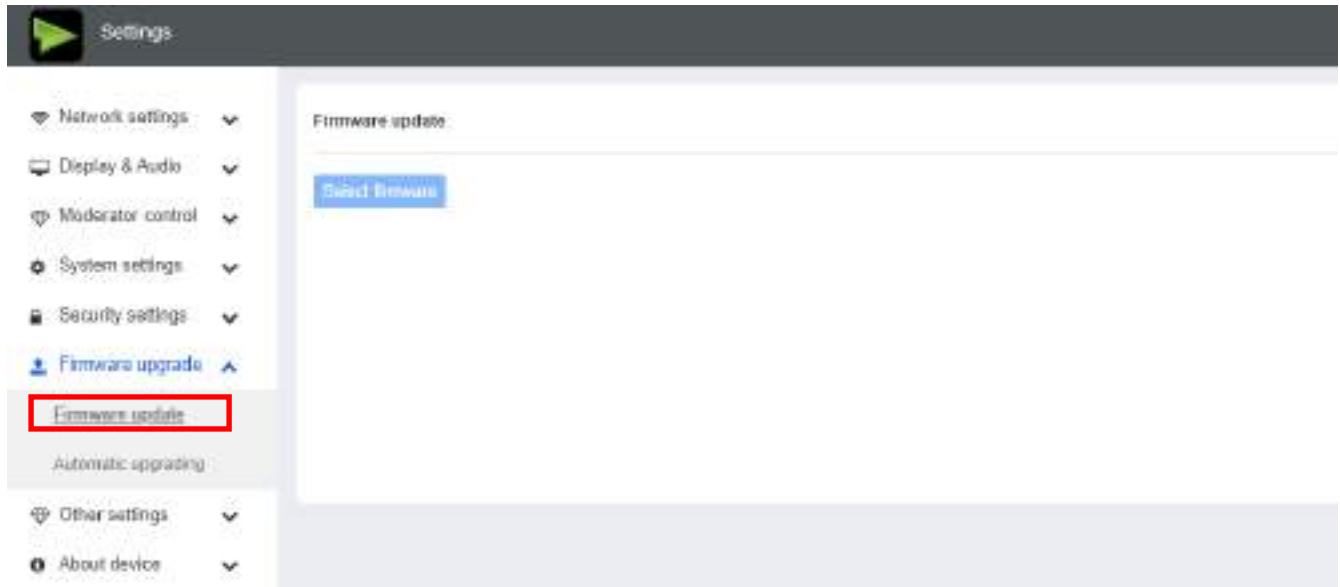

6.6.2 Automatic Upgrading

Tick to choose upgrading from OTA via Internet or from local files.

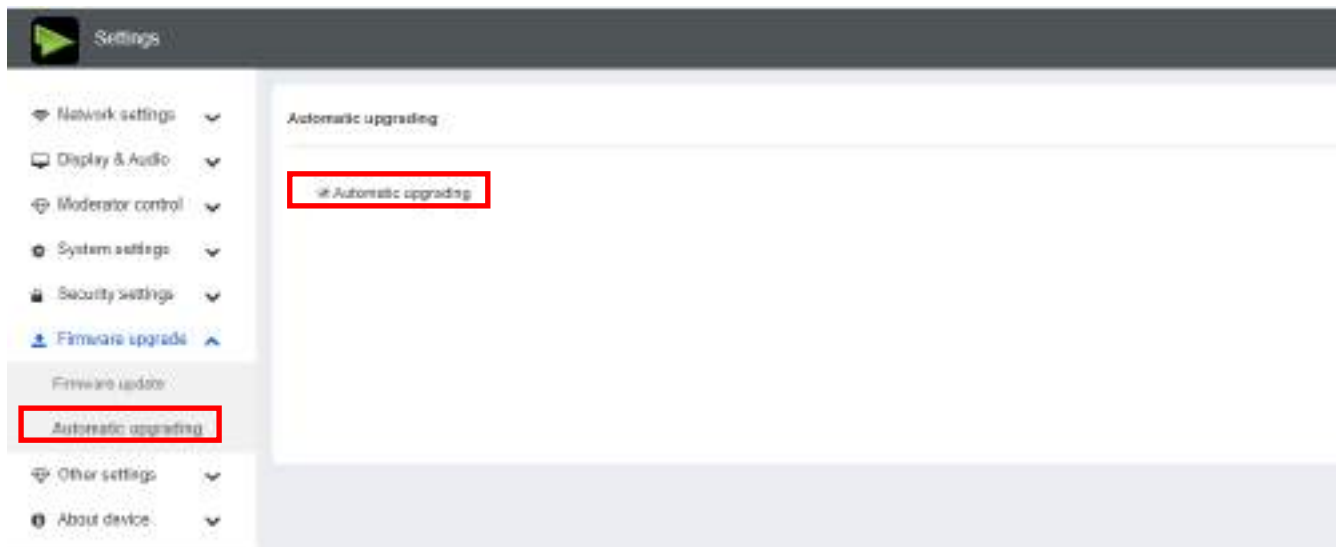

6.7 Other settings

6.7.1 Auto create launcher

Determines, when using a USB memory at one USB-port of Base-unit, the Launcher program "MTC-4000" will be copied automatically on USB memory. Enable or disable the corresponding box.

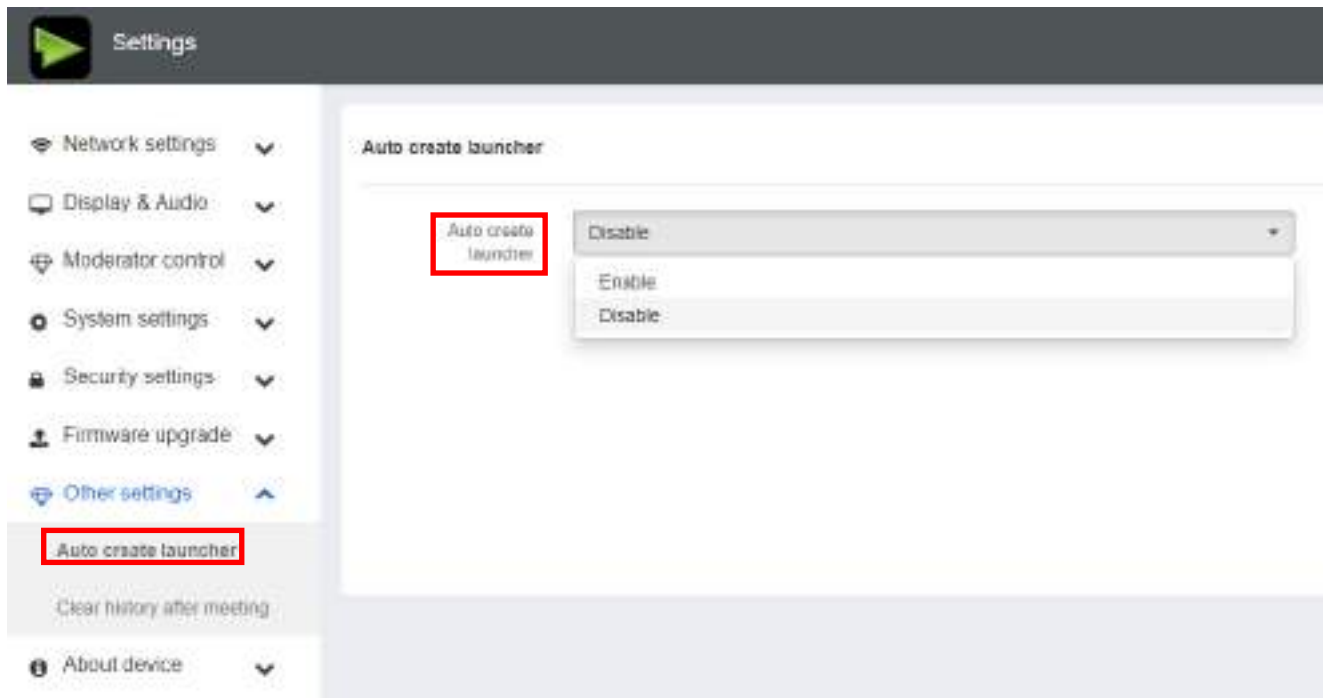

6.7.2 Clear history after meeting

Pictures, videos, music of mobile units will be stored in memory of Base-unit. This memory can optionally be erased, at the end of a meeting, when the dongle is pulled from the Laptop / PC.

Settings are:

- Decide by User – a dialog appears, when dongle is pulled.
- Never – storage space is automatically erased, when memory is filled for 90%
- Always – memory is automatically deleted.

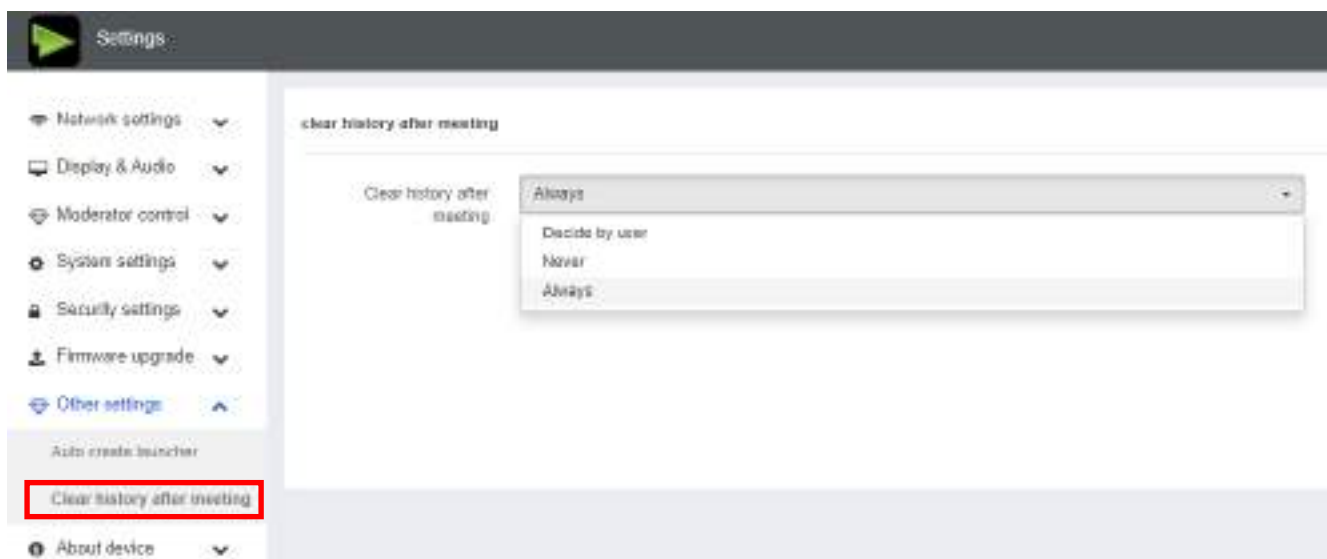

6.8 About device

Check the firmware version of base unit and web server version.



7. Updating MTC-4500

An update of the firmware can be useful to take the advantage of new features of MTC-4500 or to fix known issues and bugs. MTC-4500 includes two methods of updating. Updating by USB stick and webserver.

After updating the Base-unit, always check, whether the other parts still fit together or should be updated also.

There are **up to three different areas** for updating: Firmware **Base-unit**, Firmware and **Launcher** for PC/Laptop or MAC "MTC-4500.exe". All software is stored in Base-unit, to be transferred manually to different devices.

7.1 Check current firmware information

Base-unit: webserver "console" menu / About device.



Windows OS:

Dongle/Launcher: firmware version can be visual in the ""MTC-4000".exe" program icon in windows status bar by right-clicking the ""MTC-4000"" icon and select "About", as shown below.

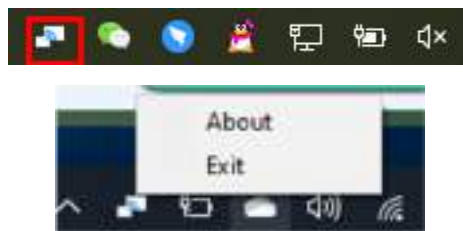

Click "About" to check dongle and launcher program version.

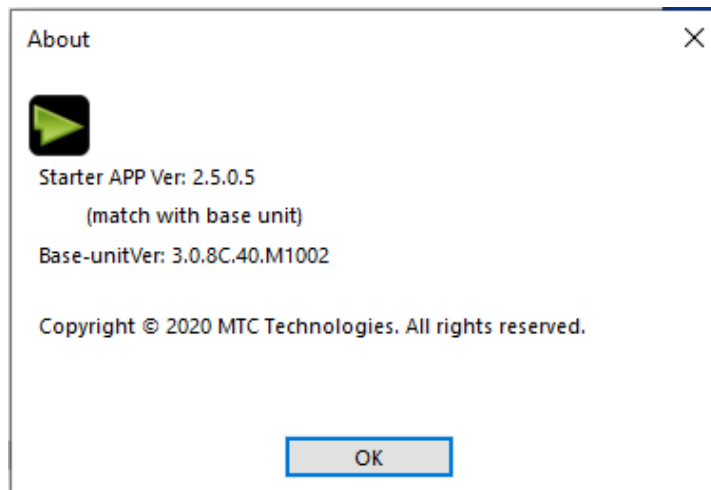

MAC OSX:

Dongle/Launcher: firmware version can be visual in the ""MTC-4500".app" program icon in MAC OSX status bar, by clicking the ""MTC-4500"" icon and select "About", as shown below.

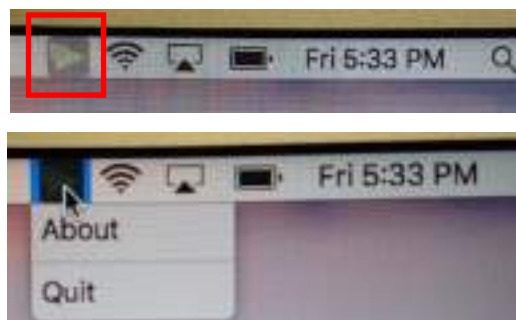

Click "About" to check dongle and launcher program.

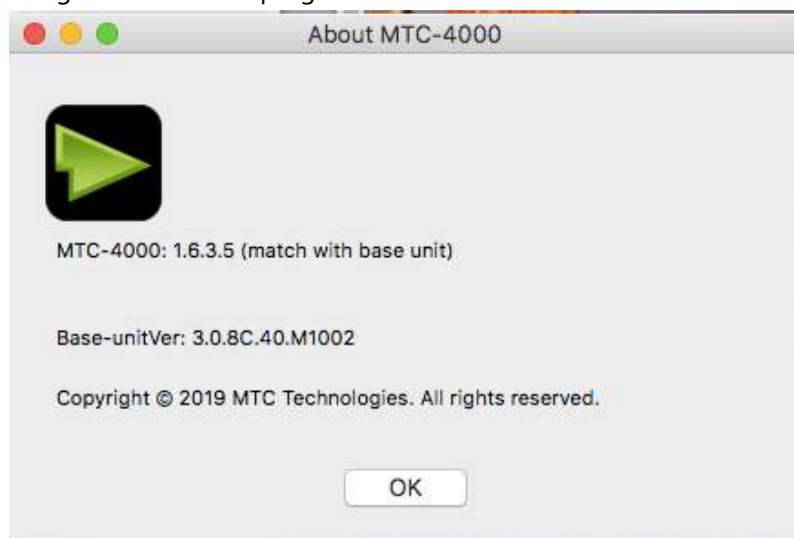

Firmwares are NOT matching:

When dongle firmware or "Launcher" firmware are older version, or in other words dongle firmware or "Launcher" firmware doesn't match with the base unit version, it shows up ""MTC-4500" ATTENTION" alert message box in the window OS or MAC OSX, as below.

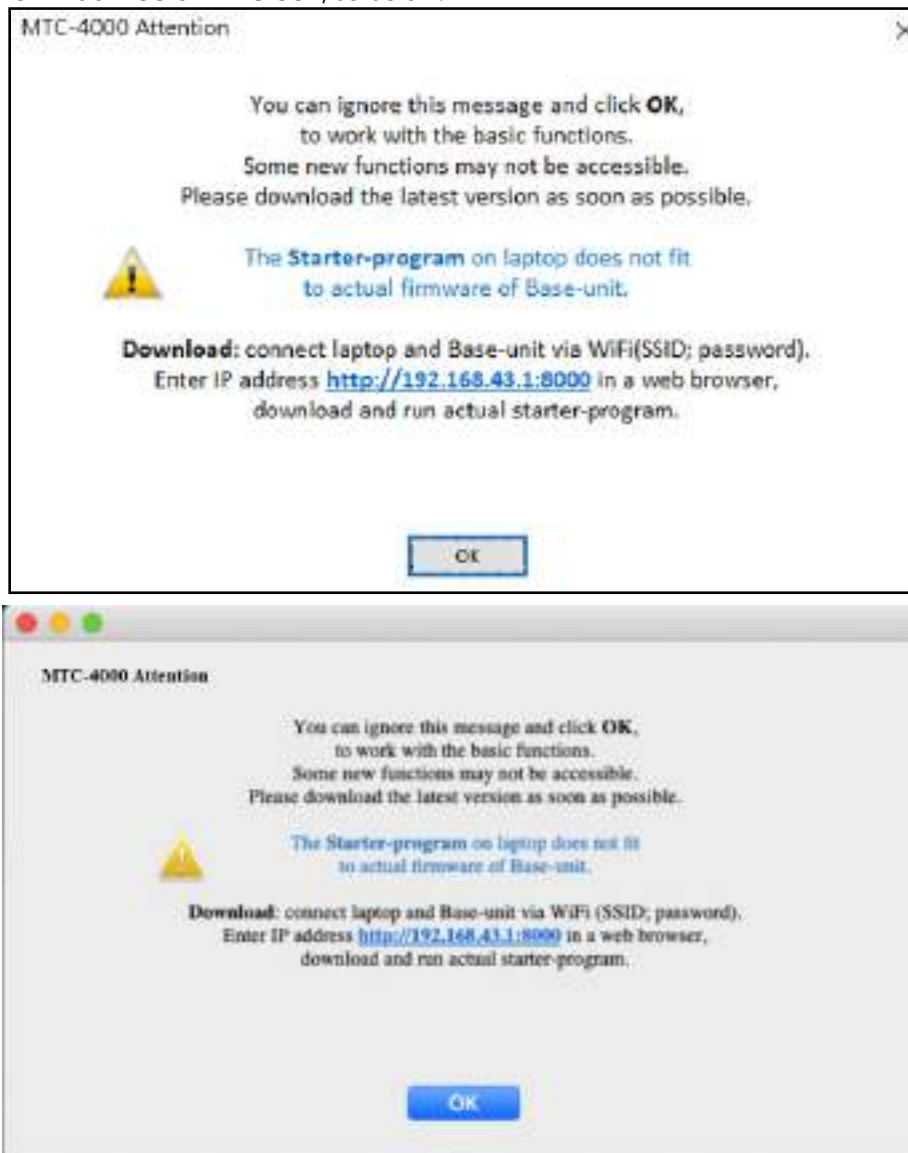

When mismatching occurs, please do the following steps to update the firmwares, as indicates in the message box.

7.2 Upgrading firmware of base unit:

There are two ways to upgrade base unit as below.

First method to upgrade base unit as below:

The base unit device can be updated through a USB drive as below.

1. Copy the updating file "update.img" to the root directory of the USB drive.



2. Connect the USB drive to either USB port of **Base-unit**.

Note: The USB port can only support maximum 500ma. Please use a small power U-disk as upgrading USB drive.

MTC-4500 recognizes the "update.img"-file at a plugged-in USB stick automatically and starts the "Full Update" procedure.

You can plug out the USB stick within 10 seconds to stop the update.

Attention !

Do not disconnect power during upgrading progress. Or, the unit firmware will be corrupted.

3. The upgrading progress displays as shown below, and the unit will reboot automatically after complete the updating 100%, as shown below.

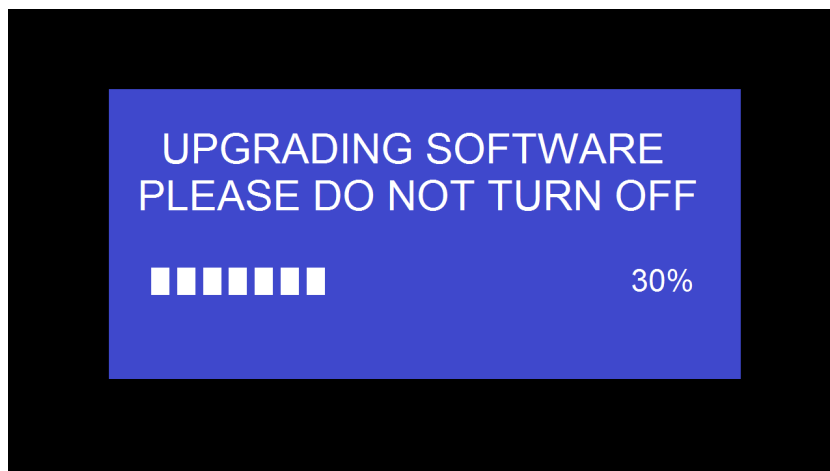

Note: During the update, screen can be temporary dark.

If the progress bar stops at 1%, use another USB stick, it may be defective.

The display device shows the Home Screen after normal boot of the device, you can disconnect USB-drive.

4. Perform "Factory Reset" when the firmware update is complete?

Only when the associated "Release notes" are requiring an additional „**Factory Reset**“, perform it via the menu "**System settings**" / "**Reset**" on webserver console menu.

All data of configuration will be lost. So that you do not have to re-configure all data in an elaborate process,

therefore note all settings within the Sub-menus before doing Factory Reset.

5. The update of Base-unit is finished.

Second method to upgrade base unit as below:

Base unit can be upgrade via webserver console menu as below:

Select a "update.img" file to upgrade to target version.

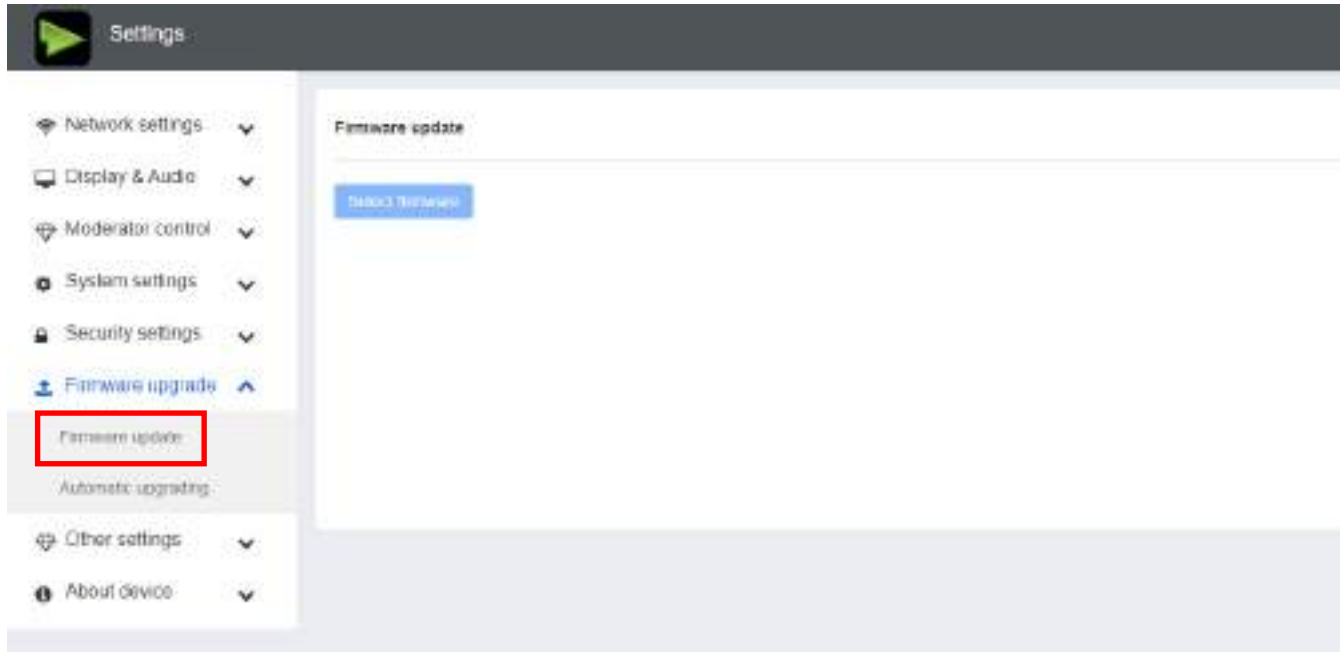

7.3 Upgrading and Pairing of Dongle:

1. Plug the dongle to either of the two USB port of MTC-4500B to be updated. It will automatically show up a message to indicate if the installed firmware of dongle is older, and needs to be upgraded.

Note: Type C dongle needs to plug into Type-C port of front base unit to upgrade.

The upgrading progress starts automatically with the progress bar, as shown below.

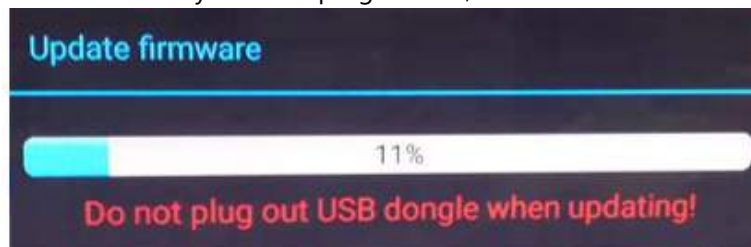

2. "Pairing" to the Base-unit is done automatically afterwards, it shows as below



3. Plug out the dongle. Now, the upgrading progress is finished. Update all other dongles accordingly.

7.4 Upgrading Launcher:

Attention: The USB driver should be FAT 32 format not NTSC format.

After upgrading **Base unit** and **Dongle**, the launcher should be written with the actual launcher program for Windows, MAC and Apps for mobile-units.

There are 2 methods to update the USB stick/launcher, including:

Method 1: Via USB stick

1. Connect the USB drive to either USB port of base unit.
2. Click the "Download" icon  in "Home Page", pls see as below:



3. The Launcher "MTC-4500" is written to the USB-stick, an OSD-windows shows the progress. When ready, unplug the USB-stick.

Method 2: Via WIFI

1. Connect PC to MTC-4500B's SSID and enter password in homepage, see pictures as below:



2. Open Browser and enter WiFi IP: 192.168.43.1:8000.
3. Click to enter "Launcher" download webpage. Shown as below:

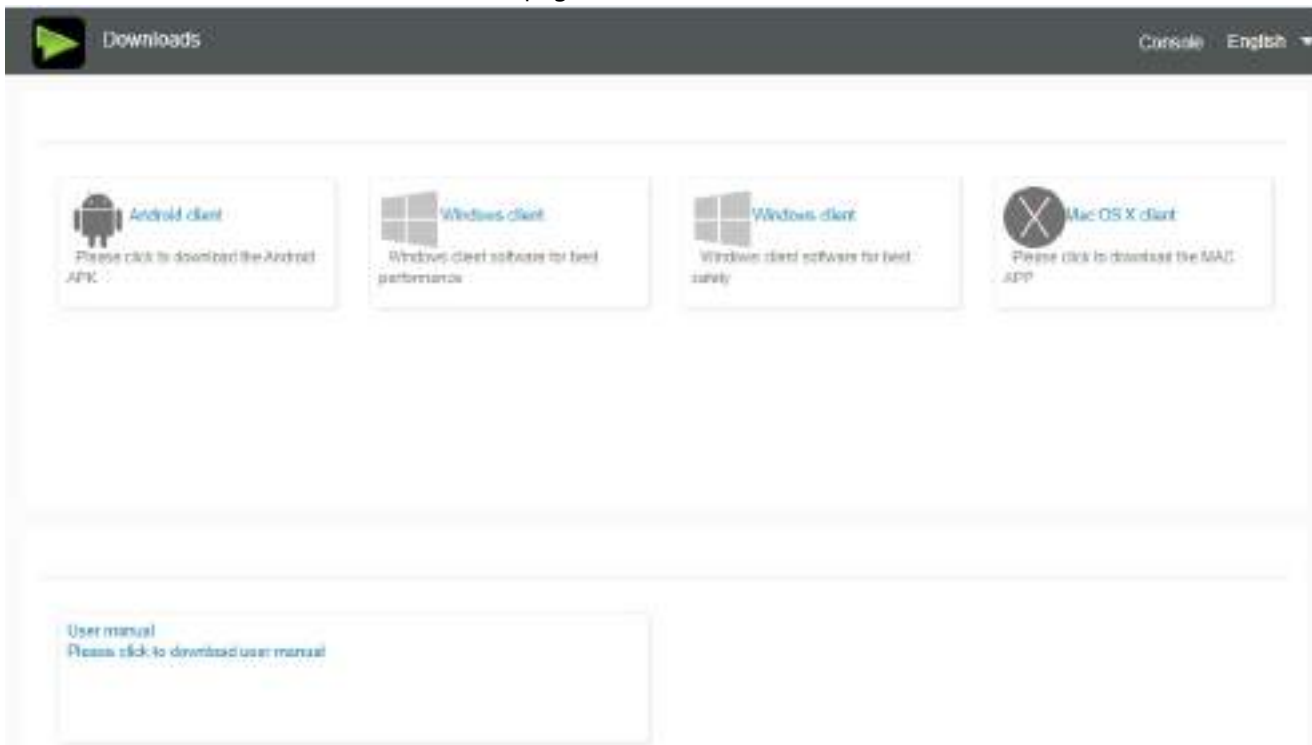

4. Choose and click Windows or MAC launcher to download.
5. Find the "Launcher" program in PC and copy to PC desktop. (Recommend to copy to desktop for quick run.)
6. Run the program to start sharing.

Two methods to execute the launcher for first time user

- Copy the program to PC, and click to execute it to share PC screen.

- Connect dongle to PC; click to run program from the USB drive and share PC screen.

For both two methods, user don't need repeat the above steps since the second time plug-in.

The Launcher program "**MTC-4500 for Windows**" and "**MTC-4500 Pro for Windows**" includes by default an additional virtual driver "ExtendedDesktop" to optionally install the Windows 10 Extended Desktop functionality, if they are needed. This may require admin rights.

7.5 Clean left files of older versions of Launcher program in Lap-top

There are some old version "MTC-4000" files left in the lap-top, which may influence the performance of the newer "MTC-4000" program. Currently, it needs to manually clear them, before start to use the newly updated "MTC-4000" firmwares.

Steps:

1. Find the place where the left "MTC-4000" programs are stored. Normally, these files are stored in the C:\Users**(user name)\AppData\Local\MTC-4000, as shown below.

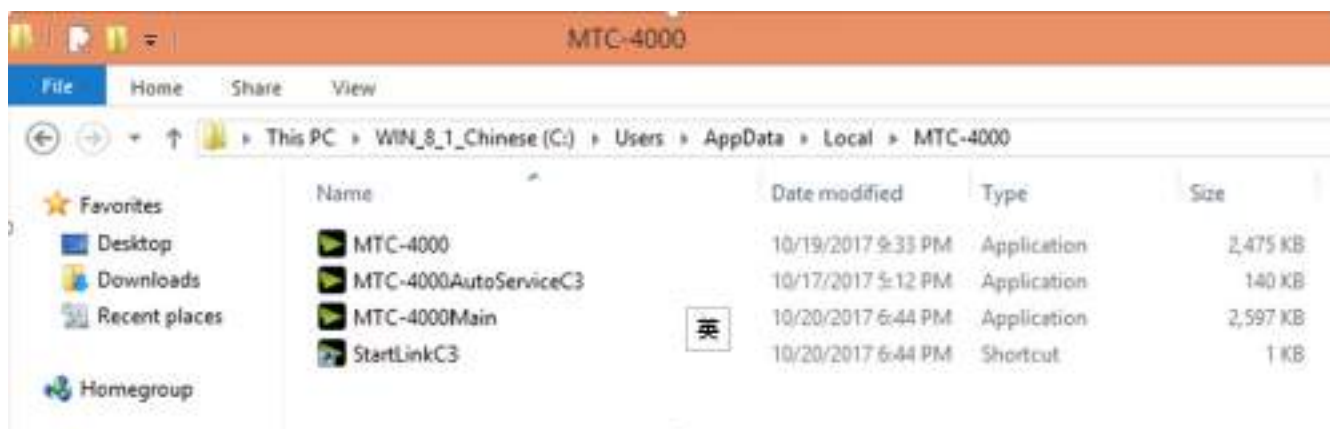

- 2.
3. If the "*.service" "*.serviceC3" can't be removed and shows up an alert message as below, please use combined hot key to open the task manager by pressing "**Ctrl+Alt+Delete**", as shown below.

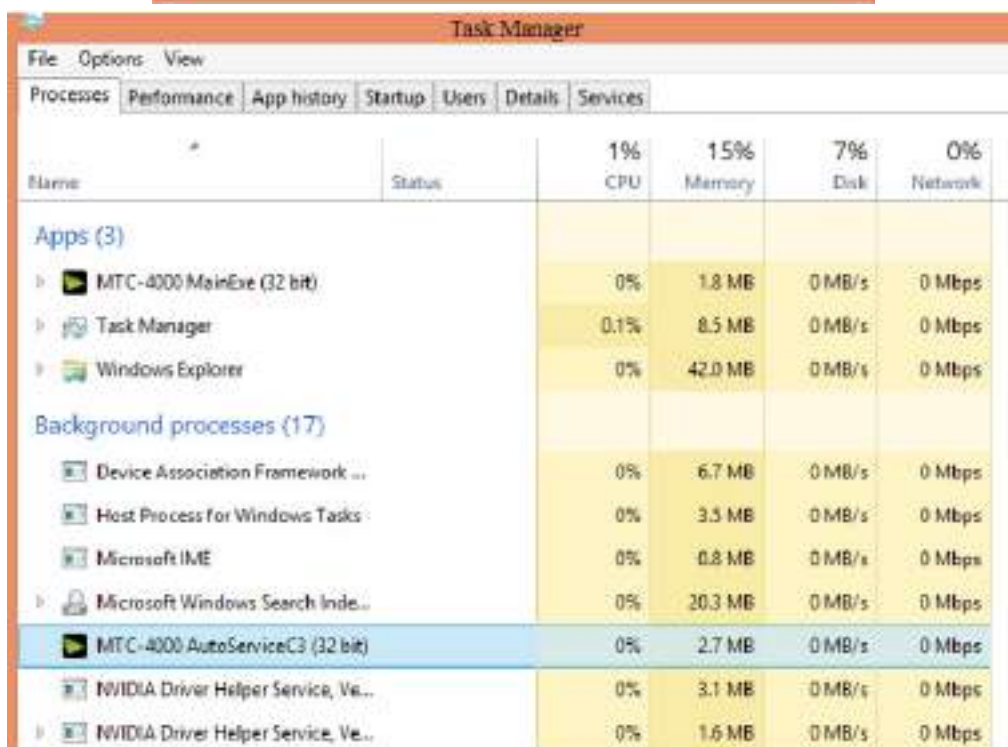
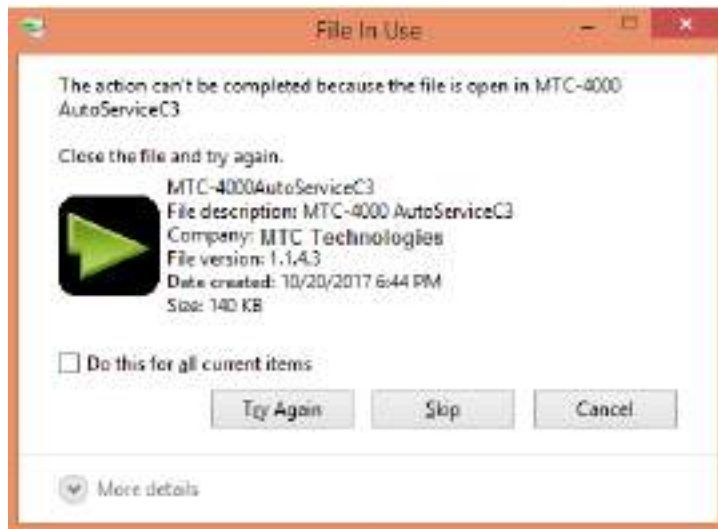

4. Right-Click on the "*.service" or "*.serviceC3", for example right-click on "MTC-4000AutoServiceC3.exe" as shown below, and click to End Process Tree.
5. Check again the task manager, to be sure there is no more any "MTC-4000" programs still running in the task manager. And check again to be sure there is no more any "MTC-4000" in the C:\Users***(username)\AppData\Local\MTC-4000".
6. Execute the actual version of Launcher program.

Upgrading progress is completed.

8. Operation Guide

8.1 Mirroring PC desktop

You can operate MTC-4500 for Windows optionally **with** or **without Dongle**. If there are several participants in a meeting, mixed operation is also possible.

8.1.1 Extended Desktop for Windows 10

The Launcher program "**MTC-4000 for Windows**" and "**MTC-4000 Pro for Windows**" includes by default an additional virtual driver "**ExtendedDesktop**" to optionally install the Windows 10 Extended Desktop functionality, if it is needed.

8.1.2 Microsoft Windows PC/Laptop with Dongle

Operating system requirement: Windows XP/Vista/7/8/8.1/10 32 & 64 bit.

For first time user, you have to **copy the Launcher program "MTC-4000" first on your Laptop. Run this Launcher program. (For MTC-4000D,MTC-4000U).**

When the Launcher program is pre-installed one time and already run in the first time, with plug in dongle, continue with step 2.

When Launcher program is not yet installed on PC, refer to chapter 7.4.

1. Plug dongle (MTC-4000D,MTC-4000U) **to the USB port of your PC or Laptop**. The MTC-4000 application is starting automatically and a symbol is displayed in the task bar of the PC/laptop  .
2. Until the transmitter button (of MTC-4000D, MTC-4000H) shows a static **green** LED indicator, or till you see a message table showing up "**Ready to share**" (for MTC-4000D, MTC-4000U), you could click it to start mirroring.

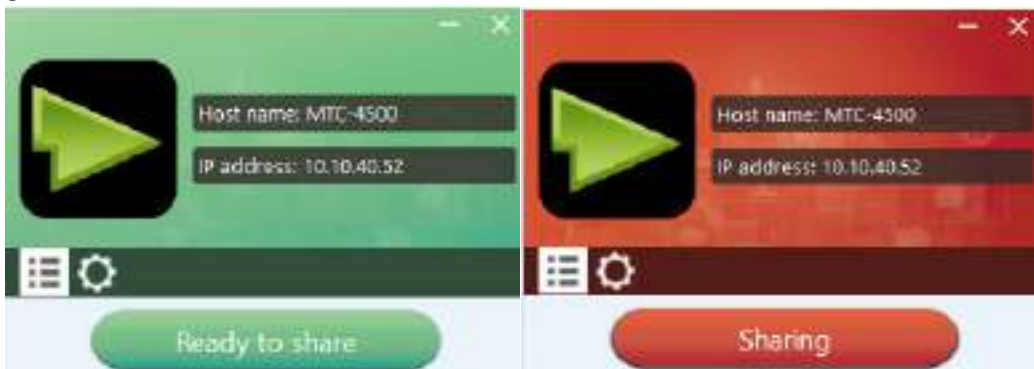

3. Click dongle (MTC-4000D, MTC-4000H) or the visual button again to stop mirroring, LED or window color shows green again.

Right click the MTC-4500 status icon  in Windows taskbar to open up the **context- menu**.

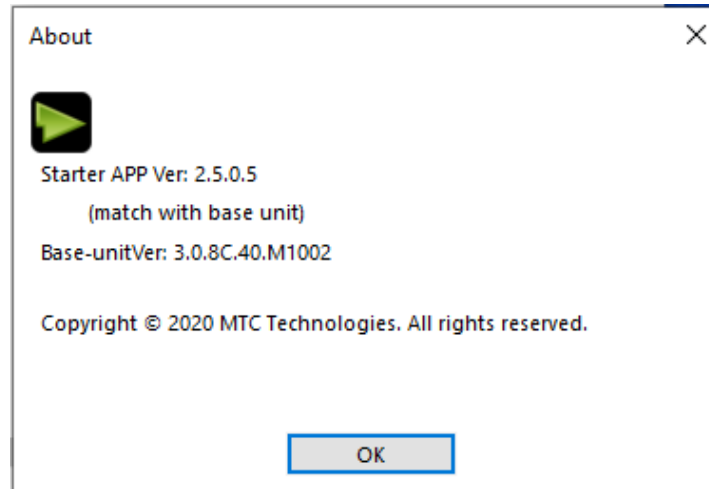

- **"About"**: You can check the software versions of the Base-unit, the dongle and the launcher program.



- **"Exit"**: End APP. Exiting the App completely.
If you click the cross "X" in the upper right corner of the app, the app in the task bar is only minimized and can be recalled again from the taskbar at any time.

8.1.3 Microsoft Windows PC/Laptop without Dongle

For first time user, you have to **copy the Launcher program "MTC-4000 for Windows" first on your Laptop. When the Launcher program is already loaded, continue with Step 2.**

1. When Launcher program is not yet installed on PC, refer to chapter 7.4.
2. Connect your laptop to **WiFi network displayed on the Home screen** ("Guest", "Staff"), or connect to the **LAN** on the network using a network cable.
3. Double-click the "**MTC-4000-windows.exe**" Launcher program  , a list of all available "MTC-4500" in the **same network** will be displayed, select which device you want to connect to. The connections are password protected (lock icon ).



(LAN connection: several receivers possible)

(WiFi: only 1 receiver)

4. Enter base unit password and click "connect", the system is ready to share.



You can also manually connect by entering the name (SSID) or IP address. (click icon .

Enter the corresponding base unit password, press 'OK', the system is "Ready to share".

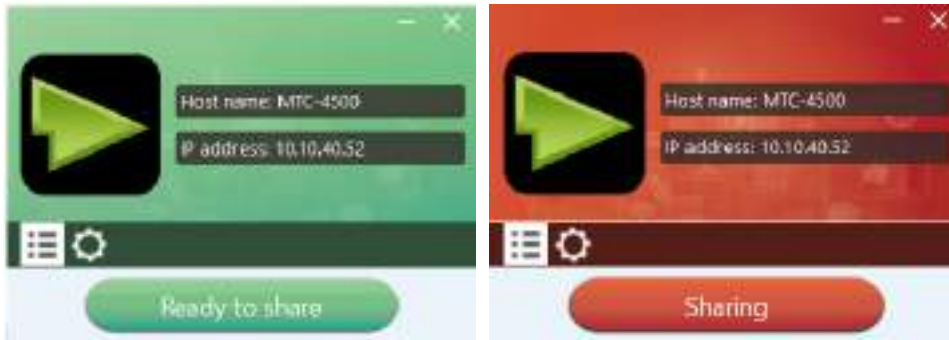

5. Click "Ready to share" in PC, when window color is static red, the screen is mirroring to the main screen.



6. Click the **visual button again**, to stop mirroring, window color shows green again. You can minimize the APP-window, in Windows taskbar you can see if screen is mirroring   or not .

Right click the MTC-4500 status icon  in Windows taskbar to open up the **context- menu**.

- **“About”**: You can check the software versions of the Base-unit, the dongle and the launcher program.

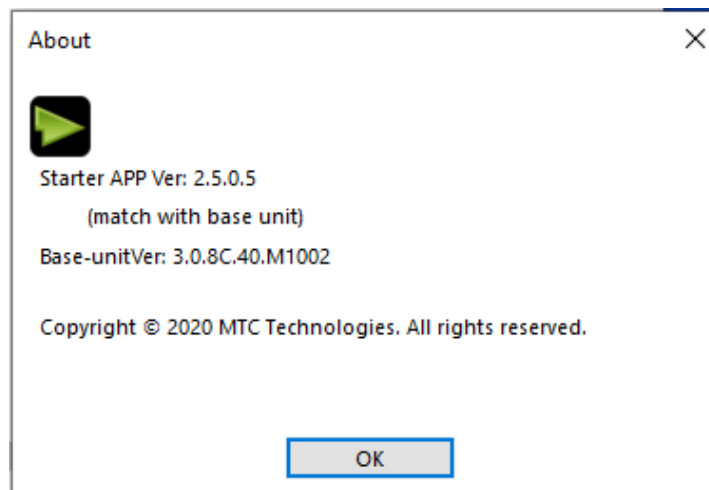

- **“Exit”**: End APP. Exiting the App completely.
If you click the **“close”** in the upper right corner of the app, the app in the task bar is only minimized and can be recalled again from the taskbar at any time.

8.1.4 Options for Microsoft Windows PC / Laptop – Extended Screen

Click the icon  in App to open/close “options”.



“Options”:

- **Extended Screen:**

Transfers extended desktop of active source. (depending on your operating system, may require the installation of the virtual driver **“ExtendedDisplay”** for function with Windows 10).

The primary screen (1) is displayed on the laptop and the virtually extended screen (2) is displayed on the main screen. If the PC has already connected an extended screen (3), the extended screen (2) will always be displayed on the main screen.

For the first time use of function “Extended Screen”, click the “Extended Screen”, will pop out a message to indicate the installation of the “ExtendedDisplay” driver. Click “yes” to continue, once installed, the “Extended screen” function is ready to use.



Note:

If you select the "Extended Screen" feature, Windows automatically switches to "Extended Mode". If you stop the transfer with MTC-4500 (Pause), Windows remains in "Extended Mode" until you press "**Windows key + P**" on the laptop to select the "PC screen only" mode.

"Remote control" is available for "Extended screen" since Firmware version V3.0.7C.40A1020.

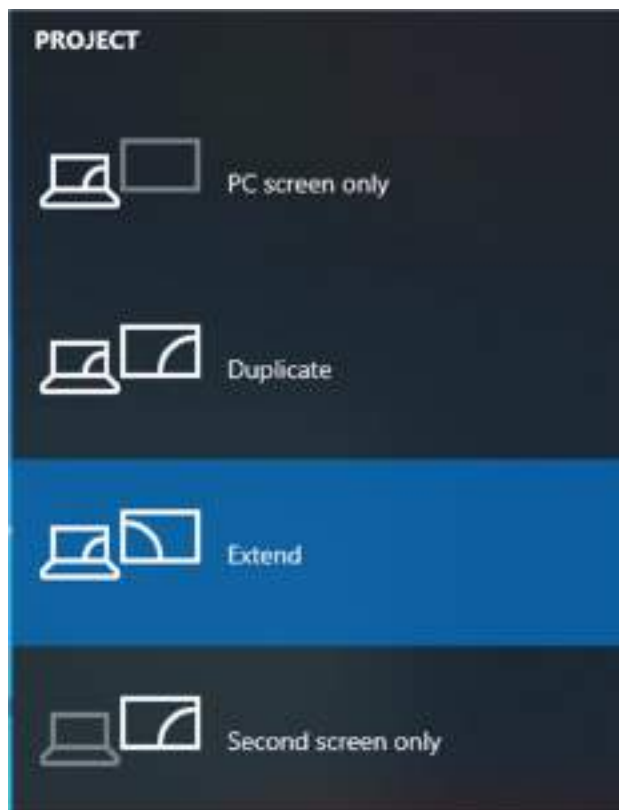

- **Keep Aspect Ratio:**

Keep the original aspect ratio to display on the main screen.

- **Stream Mode:**

- Fluency Priority: Default
- Quality Priority: Better quality on video and audio.

- **Low Latency Mouse:**

The setting is applied individually for this laptop only. The shape of mouse-pointer is equal the shape in application. There may be a small delay in movement of the cursor (approx. 150 ms). The movement of mouse-pointer is displayed very smooth with **hardly noticeable delay** (about 20 ms) on the main screen, which significantly improves the operation of the application from the main screen. The look of the mouse pointer is every time, in all applications, like a typical cursor arrow.

- **Volume Slider:**

Adjust the playback volume of the main screen when presentation laptops is active.

8.1.5 MAC OS PC/Laptop with Dongle

At least **operation system macOS 10.9** is required.

For first time user, you have to **copy the Launcher program "MTC-4000 for MAC" first on your Laptop (for MTC-4000D, MTC-4000U). Run this Launcher program.**

When the Launcher program "MTC-4000 for MAC" is already loaded, continue with Step 2.

1. When Launcher program is not yet installed on PC, refer to chapter 7.4.
2. Connect your laptop to **WiFi network displayed on the Home screen** ("Guest", "Staff"), or connect to the **LAN** on the network using a network cable.
3. Plug a dongle **to the USB port of your MacBook**. The MTC-4000 application is starting automatically and a symbol  is displayed in the dock and in top menu-bar.
4. Until the transmitter button (of MTC-4000D, MTC-4000H) shows a static **green** LED indicator, or till you see a message table showing up "**Ready to share**" (for MTC-4000D, MTC-4000U), you could click to start mirroring.



5. Click dongle or visual button again to stop mirroring, LED or window color shows green again.

Right click the MTC-4000.exe status icon  in Windows taskbar to open up the **context- menu**.

- **"About"**: You can check the software versions of the Base-unit, the dongle and the launcher program.



- **"Exit"**: End APP. Exiting the App completely.



If you click the **"close"** in the top menu bar of the app, the app is only minimized and can be recalled again in the dock at any time.

6. Disconnect at end of meeting.

8.1.6 MAC OS PC/Laptop without Dongle

For first time user, you have to **copy the Launcher program "MTC-4000 for Mac" first on your Mac.**

When the Launcher program is already loaded, continue with Step 2.

1. When Launcher program **"MTC-4000-macOS.app"** is not yet installed on PC, refer to chapter 7.4.
2. Connect your Mac to **WiFi network displayed on the Home screen** ("Guest", "Staff"), or connect to the **LAN** on the network using a network cable.
3. Double-click the **"MTC-4000 for Mac"** Launcher program , a list of all available "MTC-4500" in the **same network** will be displayed, select which device you want to connect to. The connections are password protected (lock icon ).



(LAN connection: several receivers possible)



(WiFi: only 1 receiver)



4. Enter base unit password and click "connect", the system is "Ready to share".

You can also manually connect by entering the name (SSID) or IP address. (click icon )

Enter the corresponding base unit password, press 'OK', the system is "Ready to share".

5. Click the visual button "Ready to share" in Mac, when window color is static red, the screen is mirroring to the main screen.



6. Click the **visual button again**, to stop mirroring, window color shows green again. You can minimize the APP-window, in top menu-bar you can see if screen is mirroring   or not .

Right click the MTC-4000 mac application status icon  in top menu-bar to open up the **context- menu**.

- **"About"**: You can check the software versions of the Base-unit, the dongle and the launcher program.



- **“Exit”**: End APP. Exiting the App completely.

If you click the **“close”** in the menu bar of the app, the app in the top menu-bar is only minimized and can be recalled again from the top menu-bar at any time.

8.1.7 Options for Apple MacOS, MacBook – Extended Screen

Click the icon  in App to open/close “options”.

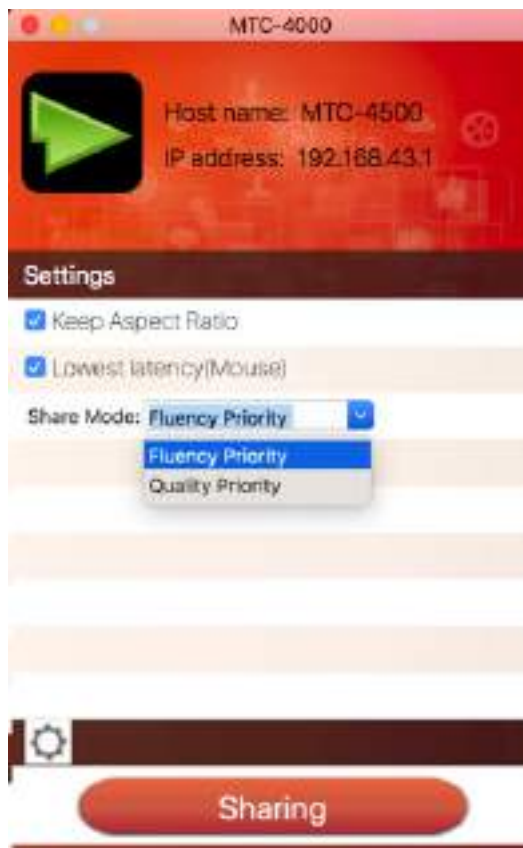

“Options”:

- **Extended Screen:**
Transmits the Extended desktop (“Use a Separate Display”) **only via AirPlay**, when activated for Display on MTC-4500.
- **Keep Aspect Ratio:**
Keep the original aspect ratio to display on the main screen.
- **Lowest Latency (Mouse):**
The setting is applied individually for this laptop only. The shape of mouse-pointer is equal the shape in application. There may be a small delay in movement of the cursor (approx. 150 ms). The movement of mouse-pointer is displayed very smooth with **hardly noticeable delay** (about 20 ms) on the main screen, which significantly improves the operation of the application from the main screen. The look of the mouse pointer is every time, in all applications, like a typical cursor arrow.
- **Stream Mode:**
 - Fluency Priority: Default
 - Quality Priority: Better quality on video and audio.

8.2 Transmitting IOS mobile device

8.2.1 How to use AirPlay?

AirPlay: MTC-4500 Base Unit supports “Airplay”, which enable mirroring the desktop of your Apple device such as iPhone, iPad etc. on the main screen.

(Note: iOS devices must first be connected to the WiFi of “MTC-4500”).

Please open the control center on the desktop with the appropriate gesture. Click the airplay icon  on your Apply device and select the receiver device MTC-4500 to connect. Now you could mirror your screen content wireless through the base unit to the main screen.

8.3 Transmit Android device wireless

8.3.1 “MTC-4500” APK for Android

1. Open the “MTC-4500” application.



MTC-4500

Note: permit access of photos and pictures, when installing.

2. Connect your mobile device to one of the displayed WiFi networks.

Guest: MTC-4500
Staff: Staff SSID

Dropdown refresh

3. The main interface of "MTC-4500" is shown as below. Click the device list refresh button which is highlighted in red circles as shown below:

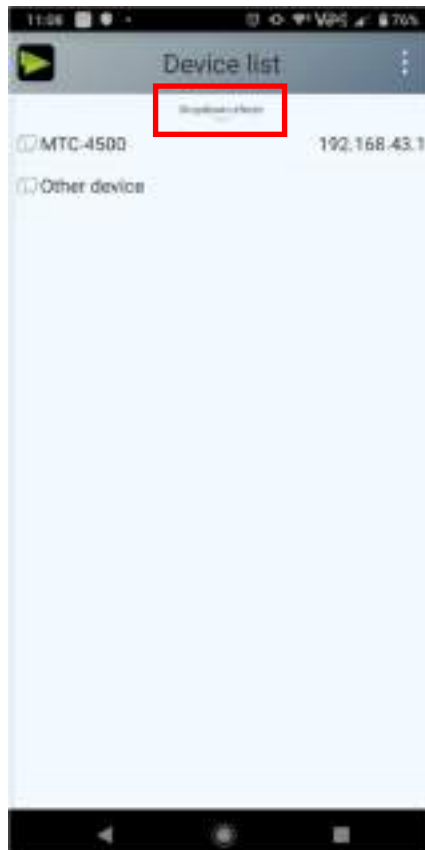

4. Select the base unit you want to connect, enter password and mirror.

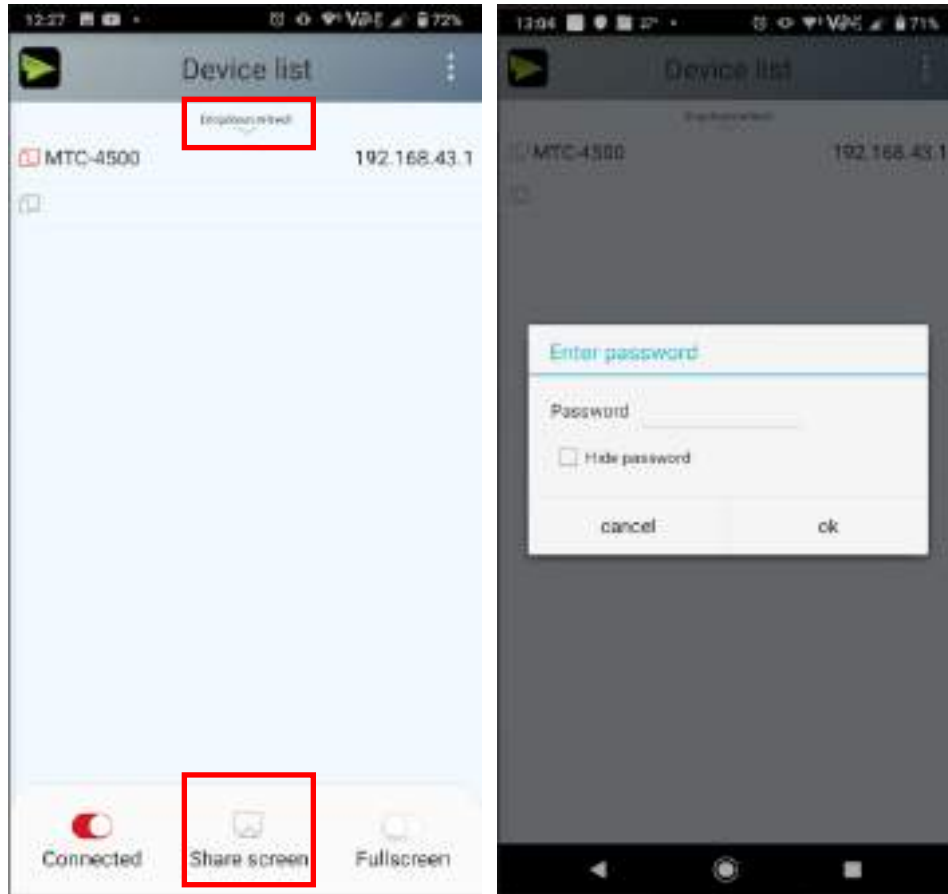

5. When sharing to main screen, it shows OSD "Welcome ***" on the home page. For example, if we connect it by a HUAWEI-PLA-AL00, it shows a "Welcome HUAWEI-PLA-AL00" on screen, as shown below.



6. Now you can mirror your desktop of your mobile.
7. Click again the button "Share Screen" to stop mirroring.

You could click "my device" to check the device status and firmware version.

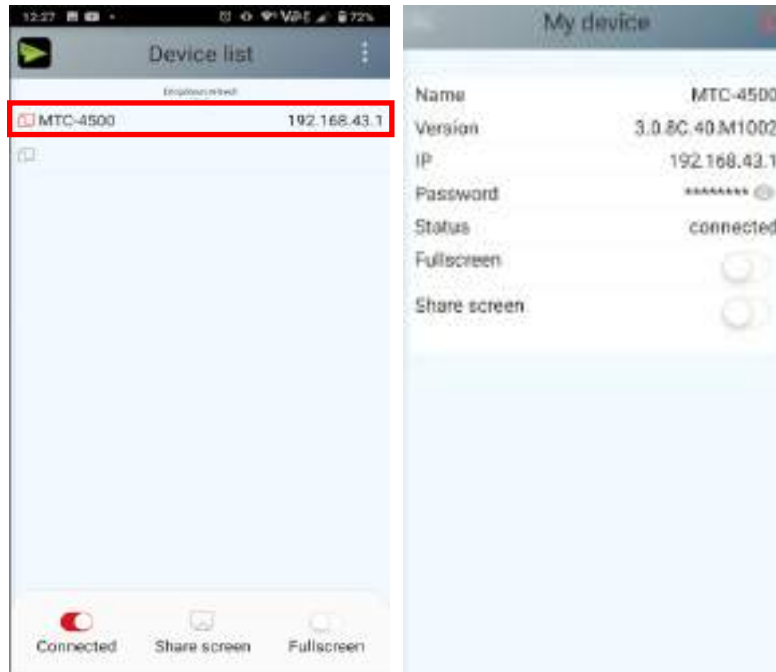

9. WIFI Recommendation Setting

9.1 Check the WIFI config on base unit

Please use a WIFI analysis software to place it at the same place as the base unit, to check the WIFI environment, in order to select the clean or unused WIFI frequency between 2.4GHz and 5Hz, and the WIFI channel as below.

2.4GHz: 1, 2, 3, 4, 5, 6, 7, 8, 9, 10, 11

5GHz: 36, 40,44, 48,149, 153, 157, 161

9.2 Check the WIFI RSSI on dongle or Mobiles

Please use a WIFI analysis software to place it at the same place as the dongle or mobiles, to measure the WIFI RSSI (Received Signal Strength Indicator). We recommend the RSSI shall be above -70dB to be good enough to keep a stable signal transmission. If not, please try to take the following measures, as in the problem shooting---
Bad wireless connection congestion.

10. Problem Shooting

Here you can find some fundamental problems and possible causes, which can be happen during the use of

“MTC-4500”. Find out the problem you’ve encountered in the table below and apply the solution.

Problem	Cause	Solution
Use “MTC-4500 for Android” application in Android device or Airplay on iOS device, and it can't find base unit device.	WiFi password of base unit changed when android or iOS device is connected to the WiFi of base unit.	Reconnect the mobile by entering password showed on home screen.
The image quality on the main display screen is not good.	The quality or length of the cable between the Base Unit and the display or the connection between these two.	<ul style="list-style-type: none"> ● Replace the cable ● Use another cable. ● Check the cable to be fasten properly.
	Improper resolution for the main screen. WMB1 could output 3840x2160_60Hz, 3840x2160_50Hz 3840x2160_30Hz, 1920x1080_60Hz, 1920x1080_50Hz, 1920x1080_30Hz	<ul style="list-style-type: none"> ● Change the resolution on the Setting configuration. And match it to the native resolution of the main screen. See chapter 7.
Bad wireless connection. The connection between the transmitter and the base unit is not stable.	<p>WiFi problems.</p> <ul style="list-style-type: none"> ● Interference in the radio channel. ● Overload in the radio channel. <p>“MTC-4500” does not automatically jump to other channels when there are changes in the RF environment.</p>	<ul style="list-style-type: none"> ● Use a WiFi scanner to find a free wireless frequency and channel and select it via the setting configuration. ● Regularly check the RF environment if there are frequently changes in WiFi networks in your environment.
	<p>Low signal strength:</p> <ul style="list-style-type: none"> ● Metal cabinets, walls, construction elements, ...can cause reflections deteriorating the wireless signal. ● Obstacles between dongles and Base unit cause lowering of the wireless strength and quality. 	<ul style="list-style-type: none"> ● Put the base unit closer to the main screen. ● Change the orientation of the antennas at the rear panel of base unit to the transmitter direction. ● Remove or limit as much as possible all obstructions between the transmitters and base unit. ● Avoid to place the Base-unit in (metal) cabinets, suspended ceilings, under tables or in adjoining rooms.

<p>Can't get the "MTC-4000.exe" run when plug the transmitter to lap-top</p>	<ul style="list-style-type: none"> ● When you are using "MTC-4500" for the first time on your laptop or for guests, you have to copy the Launcher program "MTC-4000 windows. Exe" or "MTC-4000 macOS. app" for first on your Laptop /PC. Run this Starter-program. You can run the Starter App without Admin-rights. 	<p>There are 2 possibilities to load the Launcher program, see chapter 7.4. Best is: download the App via LAN or WiFi of Base-unit. When the Launcher program is preinstalled one time, "MTC-4500" is ready to use later immediately.</p>
	<ul style="list-style-type: none"> ● Bad connection at USB port on the lap-top 	<ul style="list-style-type: none"> ● Reconnect to the USB port ● Try another USB port ● Reboot the lap-top
	<ul style="list-style-type: none"> ● Some types of USB devices might be blocked as the company policy. ● USB port setting on the lap-top might limit the usage of high power USB device when on battery power. 	<p>If possible, change the USB port policy on the lap-top</p>
<p>Low video performance (sharpness, audio and video dropouts, video stream is jerking, ...)</p>	<ul style="list-style-type: none"> ● The media-player is not ideal. ● The video quality also depends on the computing power of the PC / laptop and the interaction and CPU load with other running software applications. ● A laptop in battery mode can be switched to reduced computer power, to save energy. The transmission of HD video requires a certain amount of CPU power to guarantee the optimum quality of the transmission. 	<ul style="list-style-type: none"> ● Use another media-player (VLC player...), another browser. ● Update the software of your Video-player to the latest version. ● Reduce the CPU usage of other software applications. ● Lower the screen resolution of the Laptop. ● Update driver of graphic-card. ● End low power mode at laptop.
<p>Video is not shown on screen</p>	<p>The content use HDCP</p>	<ul style="list-style-type: none"> ● MTC-4500 input can't support showing HDCP source. If possible, connect the source device to local HDMI input at base unit.
	<p>The display cable (HDMI) is not correctly connected.</p>	<ul style="list-style-type: none"> ● Insert the display cable to the display and the Base-unit.
	<p>The displays is switched off.</p>	<ul style="list-style-type: none"> ● Switch on the display.

	The Base-unit is in standby mode, "Power-LED" is flashing at Base unit. Power-supply is missed.	<ul style="list-style-type: none"> ● Power off and on again or insert a dongle into laptop.
When using window 7 the following message about the Window Aero color scheme appears "Windows has detected your computer's performance is slow. This could be because there are not enough resources to run the windows Aero color scheme. To improve..."	MTC-4500 uses resource from the GPU. In combination with other programs which do so, Window 7 sometimes shows this message suggesting to disable Aero to improve the performance of laptop.	<ul style="list-style-type: none"> ● It's safe to ignore this message and choose "Keep the current color scheme."
Your content is removed from the display and the LEDs on the button are blinking	Connection to the Base Unit is lost.	MTC-4500 tries to restore the connection automatically. If it fails, the LEDs on the button start blinking red. Unplug the button from your laptop and try a new button.
Nothing is shown on the displays at all	The displays are switched off.	Switch on the display
	The display cable is not correctly connected	Insert the display cable to the display and the Base Unit
	The Base Unit is in standby mode	Briefly push the standby button on the Base Unit or power off and on again the Base Unit.
No LAN connection with the Base Unit	Wrong IP address	IP address is not within LAN range
		DHCP is not enabled.
No WiFi connection between mobile device with Base Unit	Wrong WiFi frequency	Check mobile device to select the correct 2.4GHz or 5GHz
	Wrong SSID and password	Enter the correct SSID
No audio when transmit local file to Base Unit	Unsupportive audio format, including Dolby MS11, DDCO DTSLBR, DTSE, DTSNeoUltra, SRS-THEATERSOUND, DTS_StudioSound3D, DTS_HD,	If possible, reformat it to the other audio format, like DD, DD+, HE-AAC, DTS DMP, WMA, DRA, COOK
There is no sound at main-display.	No connected audio device.	Make sure, the audio is turned on.
	Volume is set to OFF.	Adjust level in menu configuration MTC-4500 console in on webserver settings.
	The volume level is set too low in the options of the "MTC-4500" Launcher program on PC.	Adjust the volume in the "MTC-4500" Launcher program on PC.

	Audio signal may be muted.	Click with right-mouse button at speaker icon In task-bar and switch on.
	The volume level is set too low.	Adjust the volume level at Options in menu of MTC-4500.
	Audio is muted in mixer of volume in taskbar.	Right-mouse click at speaker icon in taskbar, open mixer and unmute "MTC-4500" or "Video Playback".
	The software of used Video-player is not actual	Update Video-player. Try another player.
	An active virus scanner can block the Audio.	Check the filter-settings in Virusscanner. De-activate the player for a check.
There is no sound with MacBook.	Problem of sound-flower App, which is integrated in driver MTC-4500.app.	<ul style="list-style-type: none"> ● You need Admin-password ● Go to the macOS System Preferences and select the "Security & Privacy" tab. Find the "allow to run/install the sound-flower" there click on "Allow" next to "Matt Ingels", in order to allow this sound-flower to install on the Mac Book. ● Run the MTC-4500.app again, it'll auto-install the sound-flower to the MacBook.
There is no sound via AirPlay.	The volume is set too low, on the mobile device.	Increase the volume on the mobile device.
There is no sound at main-screen, when mirroring a video by the App "MTC-4500 for Android" .	Due to the limit of the Android system, Android doesn't provide an interface to capture the audio. In this case, there is no sound when mirroring the video.	Use dongle or Apple Airplay to do mirroring when necessary.
Can't update firmware of the base unit.	Flash disk format is NTFS	Please re-format the flash disk to be FAT format to update it.
Can't work airplay with MacBook/iPhone/iPad.	Operation System Requirement Mac OS 10.9 IOS 8.0 and later (MTC-4500 app)	<ul style="list-style-type: none"> ● To use AirPlay, you must connect the iOS device to the WiFi of MTC-4500B base unit and enable the AirPlay feature in the Control Center. ● Update the iOS device to a newer operating system.

Poor Video-quality with AirPlay .	There are 2 states for AirPlay: a.) Mirroring: 1: 1 copy of the screen b.) Streaming: Videos (Internet, Youtube); the image will not be displayed on the iOS device. => picture is jerky	Reduce "Quality! In settings of Youtube, for example from "Automatic" to 720p.
Can't work with Android device?	Operation System Requirement Android 2.3 and later (MTC-4500 app)	Update to the later OS

11. Contacting MTC Technologies

For any inquires, issues or comments concerning our products, please send an email to the address below.

Email: info@mtc-technologies.com

Website: <http://mtc-technologies.com>

This Manual is provided for reference only. The functions of the actual products are subject to change without further notice.