

ASUS[®] MB16AHP

1

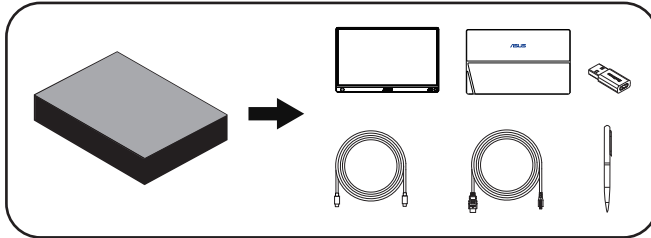

2

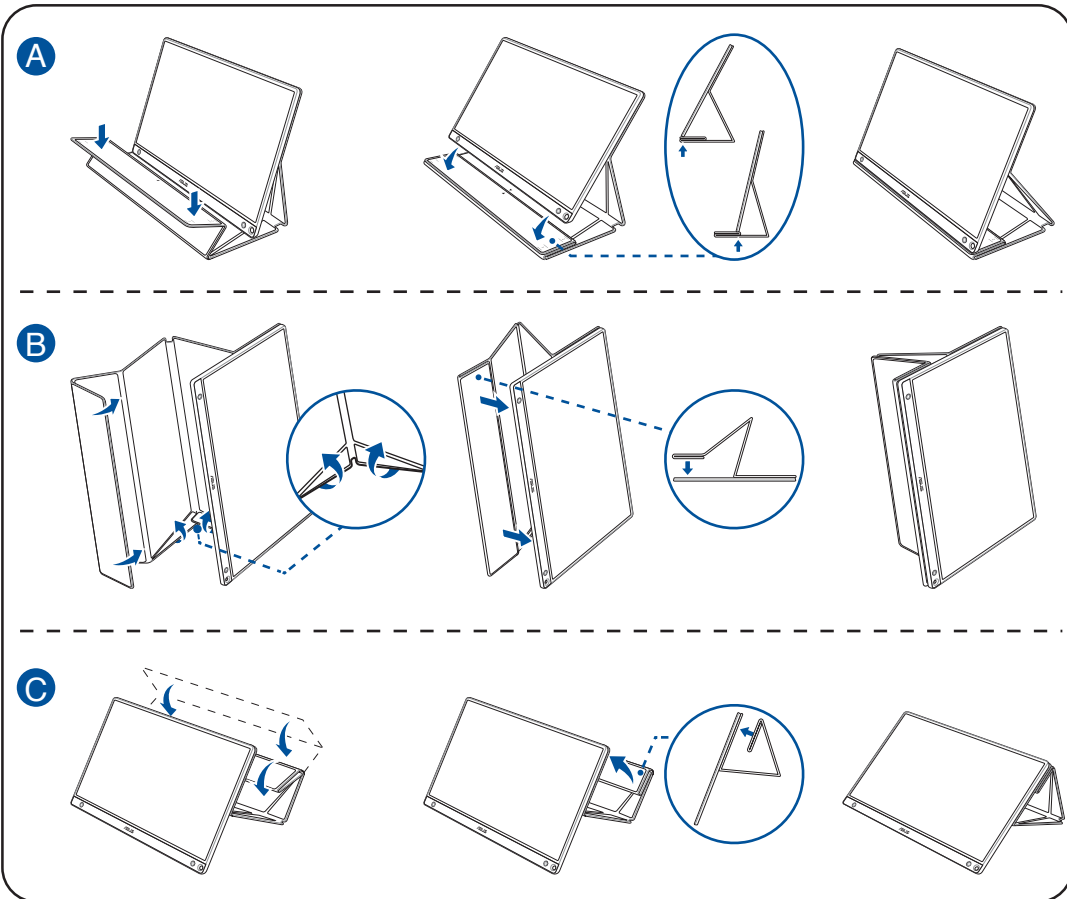

3

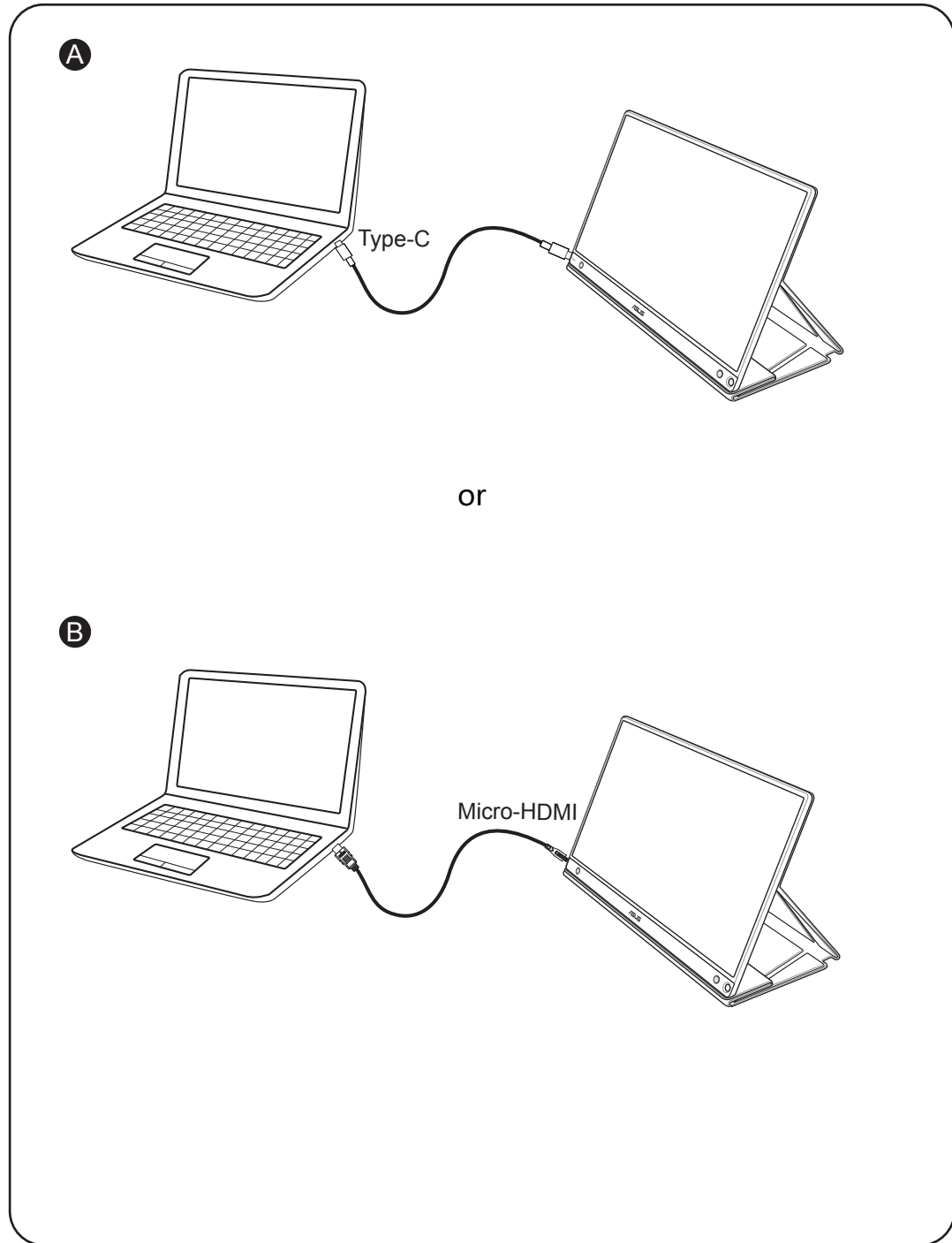

Please check ASUS website for latest User Manual, Driver and Display Widget Software update.

EAC
<http://www.asus.com>

Copyright © 2019 ASUSTeK COMPUTER INC. All Rights Reserved.



Q41G78S268065C



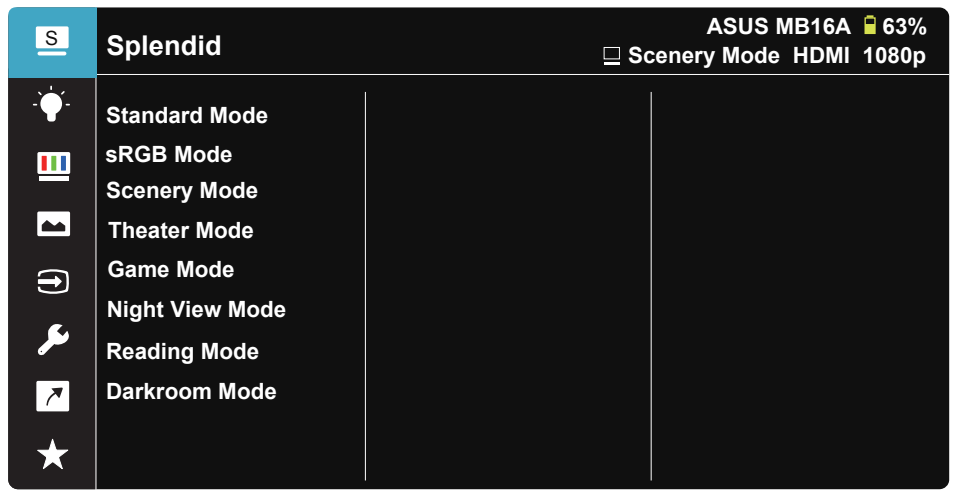
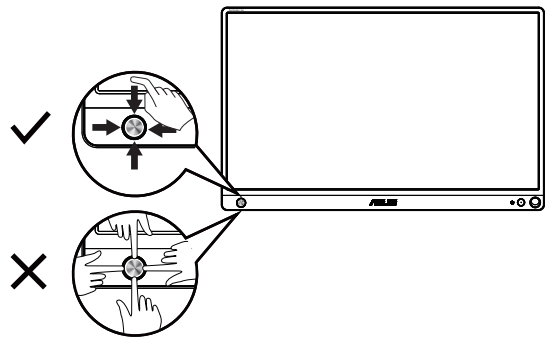
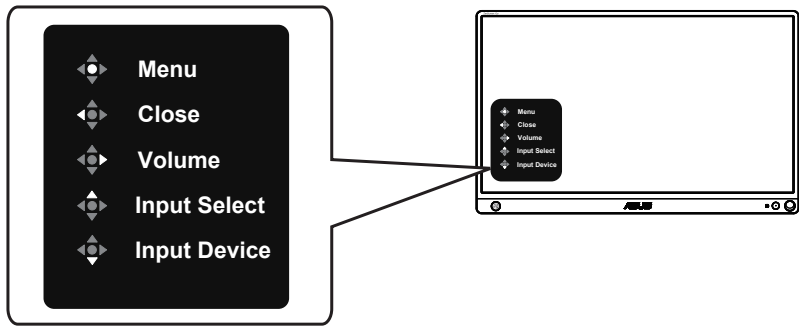
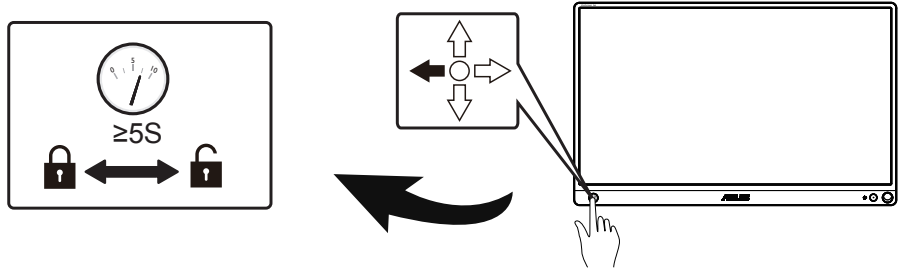
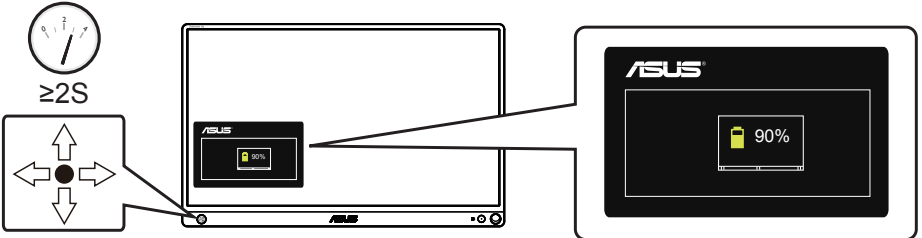

ASUS CONTACT INFORMATION

<p>ASUSTeK Computer Inc. Address 15 Li-Te Rd., Peitou, Taipei 11259, Taiwan Telephone +886-2-2894-3447 Fax +886-2-2894-7798 E-mail info@asus.com.tw Website http://www.asus.com.tw/</p>	<p>ASUS Computer International (America) Address 48720 Kato Rd, Fremont, CA 94538, USA Telephone +1-510-739-3777 Fax +1-510-608-4555 Website http://usa.asus.com/</p>	<p>ASUS Computer GmbH (Germany and Austria) Address Harkortstr. 21-23 D-40880 Ratingen, Germany Telephone +49-1805-010920 Website http://www.asus.de/ Online Contact http://www.asus.de/sales</p>
<p>Technical Support Telephone +86-21-38429911</p>	<p>Technical Support Telephone +1-812-282-2787 (English Only) +1-905-370-2787 (French Only) Online Support http://support.asus.com/</p>	<p>Technical Support Telephone +49-1805-010923 Support Fax +49-2102-959911 Online Support http://support.asus.com/</p>