

HUAWEI WATCH GT

# HUAWEI WATCH GT

Issue 01  
Date 2019-03-26



---

# Contents

---

<b>1 Getting started</b>	<b>1</b>
1.1 Using your HUAWEI WATCH GT	1
1.2 Wearing your watch	1
1.3 Screen control	2
1.4 Pairing your watch with your phone	5
1.5 Setting the time zone and language	6
1.6 Charging your watch	7
1.7 Powering on and off/Restarting your watch	9
<b>2 Basic operations</b>	<b>12</b>
2.1 Adjusting screen brightness	12
2.2 Locking and unlocking your watch screen	12
2.3 Weather reports	14
<b>3 Fitness and health</b>	<b>16</b>
3.1 Daily activity records	16
3.2 Start a workout	17
3.3 Workout status	19
3.4 Heart rate monitoring	19
3.5 Sleep tracking	21
3.6 Syncing and sharing your fitness and health data	22
<b>4 Messaging assistant</b>	<b>23</b>
4.1 Incoming call notification	23
4.2 Rejecting an incoming call	23
4.3 Messages reminders and content display	23
4.4 Deleting a message	24
<b>5 Setting alarms</b>	<b>26</b>
5.1 Setting a Smart alarm	26
5.2 Setting an Event alarm	27
<b>6 Watch faces</b>	<b>29</b>
6.1 Changing the watch face	29
6.2 Using Watch Face Store	30

---

<b>7 Apps</b> .....	<b>32</b>
7.1 Barometer .....	32
7.2 Compass.....	33
7.3 Stopwatch and Timer .....	33
7.4 Flashlight .....	34
7.5 Find phone .....	34
<b>8 Updating and factory reset</b> .....	<b>35</b>
8.1 Viewing version information .....	35
8.2 Updating your watch and the Huawei Health app .....	35
8.3 Resetting your watch .....	37
8.4 Force restart .....	38
8.5 Viewing the Bluetooth name and MAC address .....	39
<b>9 Maintenance</b> .....	<b>41</b>
9.1 Water and dust resistance.....	41
9.2 Cleaning and care .....	42
9.3 Adjusting or replacing the strap .....	42

# 1 Getting started

---

## 1.1 Using your HUAWEI WATCH GT

HUAWEI WATCH GT (hereinafter referred to as "watch") is a lightweight and fashionable smart watch with long battery life. It is designed to help you learn more about your health and provide professional workout guidance, and includes useful features such as workout monitoring, message notifications, heart rate monitoring, and GPS.

HUAWEI WATCH GT features a beautiful double crown design housing a color screen and comes with an allergy tested strap for maximum comfort and safety. HUAWEI offers a range of strap designs so you can easily find one that suits you.

To start using the watch, wear it on your wrist and pair it with your phone using the Huawei Health app. You will then be able to enable various features, such as professional workout, heart rate monitoring, sleep tracking, and message alerts.

- **Professional workout**

Optimize your workouts with a customized training plan and professional fitness advice.

- **Heart rate monitoring**

Keep track of your fitness and health with constant and accurate heart rate monitoring.

- **Sleep tracking**

Get better rest with the help of in-depth sleep pattern analysis.

- **Instant notifications**

Stay updated with notifications for messages, chat, social media, and more.

## 1.2 Wearing your watch

Please refer to the illustrations to attach the heart rate monitoring area of your watch to your wrist in order to maintain a comfortable and proper fit. To ensure the accuracy of heart rate measurements, please wear your watch properly, avoid wearing it too loose or too tight over your joints, and ensure that it is secure during high-intensity exercises.

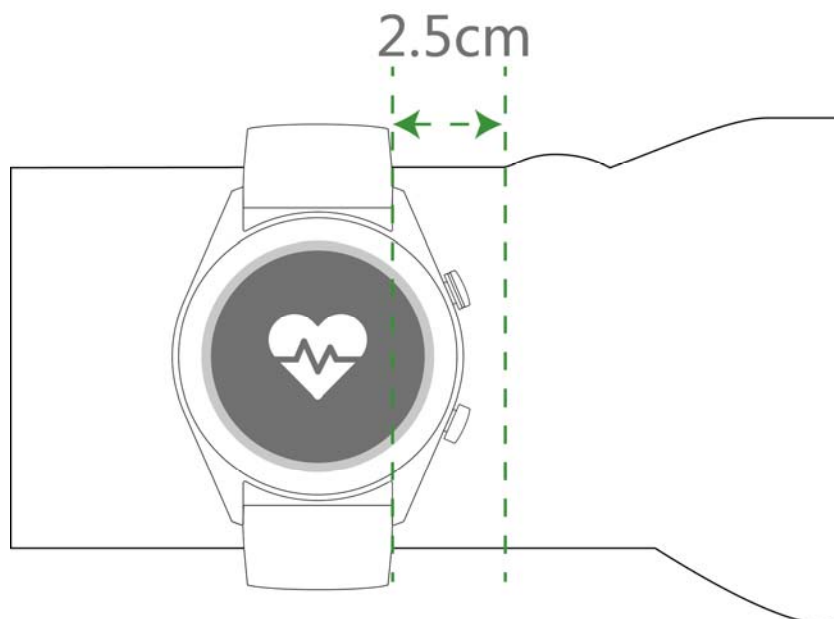

The watch strap adopts a T-buckle design so it will not fall out easily. To wear the watch, insert one end of the strap into the T-buckle and fasten it.



**NOTE**

- Your watch uses non-toxic materials which are not harmful to the body. If you have an allergic reaction, please consult a doctor immediately.
- Be sure to wear your band properly to maximize comfort.

## 1.3 Screen control

The watch features an AMOLED touchscreen. You can touch, touch and hold, or swipe on its screen.

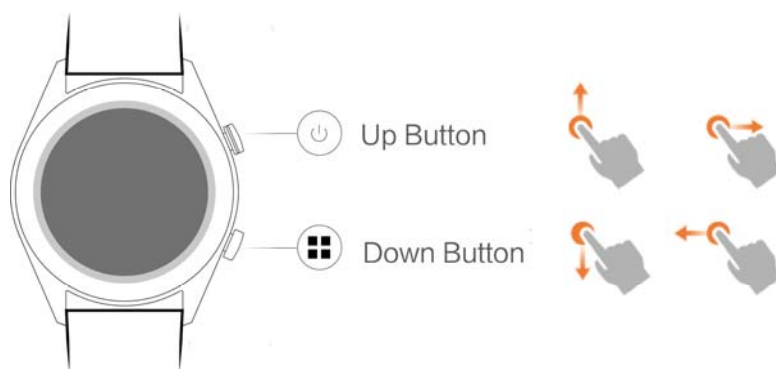

## Up button

Operation	Function	Remarks
Press	<ul style="list-style-type: none"> <li>Wake watch screen when the screen is off.</li> <li>Access the app list screen from the home screen.</li> <li>Return to the home screen.</li> </ul>	Not available in special scenarios such as calls and workouts.
Hold	<ul style="list-style-type: none"> <li>Power on your watch when the watch is off.</li> <li>Access the restart/power off screen when the watch is on.</li> </ul>	

## Down button

Operation	Function	Remarks
Press	Open workout apps	Not available in special scenarios such as calls and workouts.
Hold	Lock/Unlock the screen	

## Button functions during a workout

Operation	Function
Press the up button	Pause/Continue the workout
Press the down button	Switch screen
Hold the up button	End the workout

Operation	Function
Hold the down button	Lock/Unlock the screen
Swipe up or down on the screen	Switch screen
Touch and hold the screen	Replace data

## Gestures

Operation	Function
Touch	Select and confirm
Touch and hold the home screen	Change watch face
Swipe up on the home screen	View notifications
Swipe down on the home screen	View shortcut menu
Swipe right or left	View your heart rate data, workout data, and weather information
Swipe right	Return to the previous screen

## Wake the screen

To wake your watch's screen, you can do any of the following:

- Press the up button.
- Raise or rotate your wrist inward.
- Swipe down on the home screen to open the shortcut menu. Enable **Show time** and the screen will stay on 5 minutes.



### NOTE

You can enable the **Raise wrist to wake screen** function in the Huawei Health app.

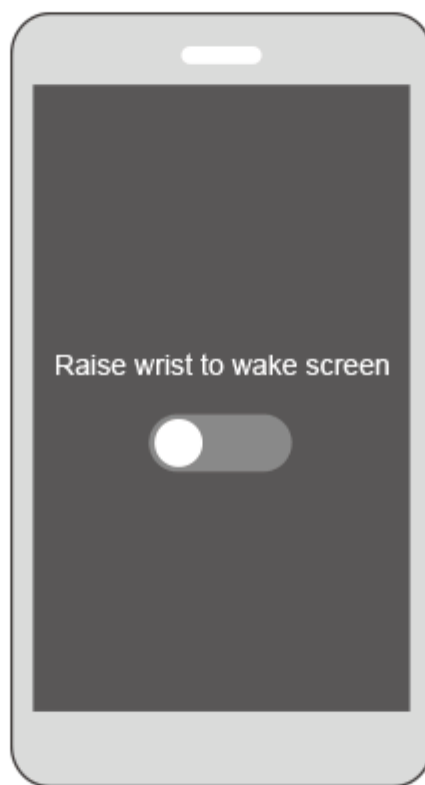

## Turn off the screen

- Lower or rotate your wrist outwards to turn off the watch screen.
- The screen will turn off automatically when the watch is idle for 10 seconds.

## 1.4 Pairing your watch with your phone

Hold the up button to turn on your watch. The watch is now ready to be paired via Bluetooth.

- **For Android users:**
  - a. Download the Huawei Health app from the Google Play Store. (On Huawei phones, you can download the Huawei Health app from the AppGallery.) If you have already installed the Huawei Health app on your phone, make sure that it is updated to the latest version.
  - b. Open the Huawei Health app and follow the onscreen instructions to set it up. Then, go to **Me > My devices > Add > Smart Watch** and touch **HUAWEI WATCH GT**.
  - c. Touch **Pair**. The Huawei Health app will search for the watch automatically. Select **HUAWEI WATCH GT-XXX** from the list of devices. The watch will start to pair with your phone automatically.



- d. When a pairing request appears on your watch screen, touch , then confirm the request on your phone to complete the pairing.

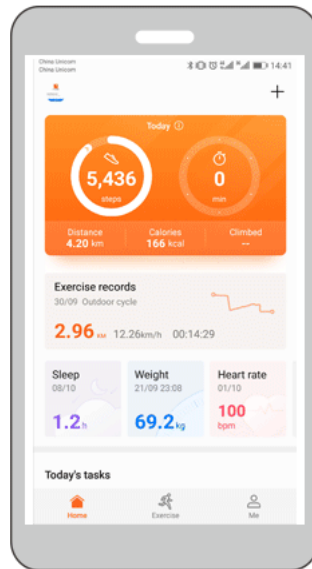

- **For iOS users:**
  - a. Download the Huawei Health app from the App Store. If you have already installed the Huawei Health app on your phone, make sure that is updated to the latest version.
  - b. Open the Huawei Health app. Access the **Devices** screen, and touch the + icon in the top-right corner. Touch **Smart Watch** and select **HUAWEI WATCH GT**.
  - c. Touch **Pair**. The Huawei Health app will search for the watch automatically. Select **HUAWEI WATCH GT-XXX** from the list of devices. The watch will start to pair with your phone automatically.

- d. When a pairing request appears on your watch screen, touch  to complete the pairing.

 **NOTE**

- Your watch screen will display an icon to inform you if pairing is successful, and start to sync information (such as date and time) from your phone.
- Your watch screen will display an icon to inform you if pairing has failed, then return to the startup screen.

## 1.5 Setting the time zone and language

The time zone and language settings on your phone will be automatically synced to your watch.

If you change the language, region, time, or time format on your phone, these changes will be automatically synced to your watch.

## 1.6 Charging your watch

### Charging

Your watch comes with a magnetic charging cradle and a USB cable, which can be used with a HUAWEI charger to charge your watch. Connect the charging cradle to the charger using the USB cable. Place your watch onto the charging cradle. Align and attach the charging port to the magnets of the charging cradle. You should see the battery level on the watch face.

#### NOTE

- Before charging, make sure the charging port is clean and dry.
- Use the original charging cable that comes with the watch.
- Use an original HUAWEI charger (5 V/1 A or higher) or your computer's USB port to charge your watch. Using other chargers may result in issues such as slow charging speed or overheating. It is recommended that you purchase original HUAWEI chargers from an official Huawei store.

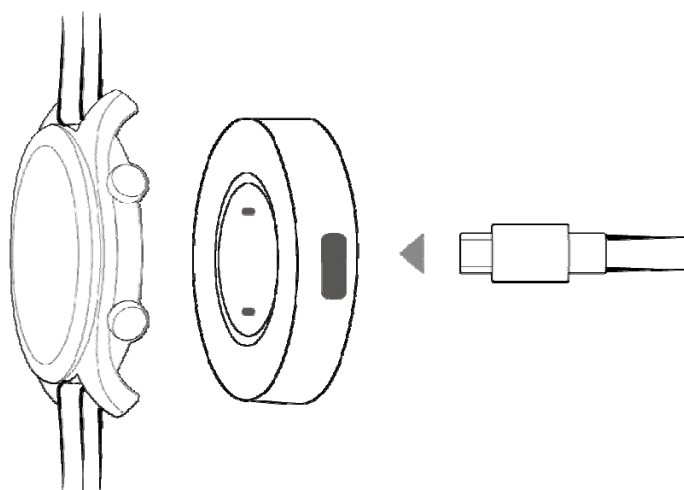

### Charging time

It takes about 2 hours to fully charge your watch. When your watch is fully charged, **100%** will be displayed on the watch screen. Remove your watch from the charging cradle once it is fully charged.

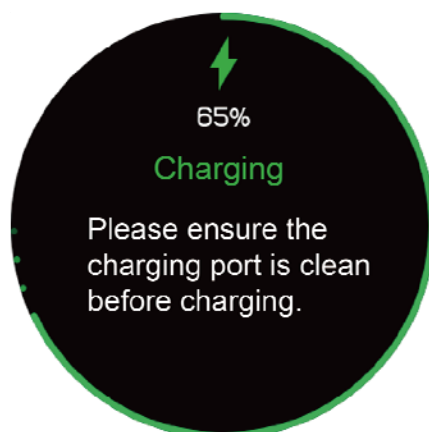

 **NOTE**

- Charge your watch in a dry and well-ventilated environment.
- Before charging, make sure the charging port is clean and dry to prevent short circuits or other issues.
- To maximize the battery's lifespan, charging current will be reduced if the surrounding temperature is low. In this case, it may take a longer time to charge your watch.

## Viewing the battery level

Use one of the following three methods to view the battery level:

**Method 1:** When your watch is charging, the battery level will be displayed on the charging screen. Press the up button to exit the charging screen.

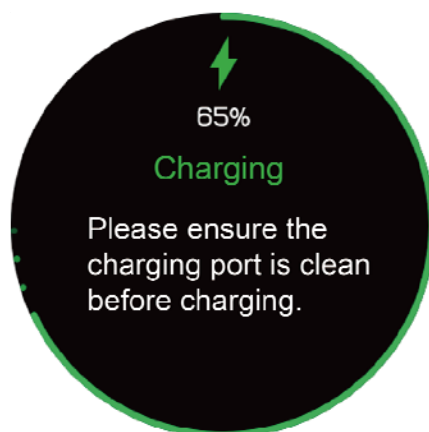

**Method 2:** Swipe down on the watch's home screen. You can view the battery level in the shortcut menu.

**Method 3:** View the battery level in the Huawei Health app.

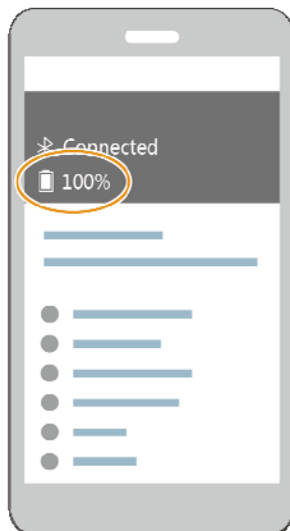

## 1.7 Powering on and off/Restarting your watch

### Powering on your watch

- **Method 1:** Hold the up button until the watch screen turns on.
- **Method 2:** Charge your watch and it will automatically power on.



#### NOTE

If you power on the watch when the battery level is very low, the watch will notify you and advise you to charge your watch. The watch's screen will turn off after 2 seconds, and you will be unable to power it on until you charge it.

### Powering off your watch

- **Method 1:** Hold the up button and touch **Power off**.
- **Method 2:** Press the up button and go to **Settings > System > Power off**.
- When your watch's battery level is very low, it will vibrate to notify you and automatically power off.



## Restarting your watch

- **Method 1:** Press and hold the up button and touch **Restart**.
- **Method 2:** Press the up button and go to **Settings > System > Restart**.



# 2 Basic operations

## 2.1 Adjusting screen brightness

On the watch home screen, press the up button, go to **Settings** > **Display** > **Brightness** to adjust screen brightness. Brightness is set to **Auto** by default, which automatically adjusts screen brightness based on your environment. Level 5 is the brightest and Level 1 is the dimmest setting.



## 2.2 Locking and unlocking your watch screen

Touch gestures will not work when your watch screen is locked. This feature is useful for preventing unintended operations (e.g. by water when you are swimming).

**Lock the screen**

**Method 1:** On the watch home screen, hold the down button.



**Method 2:** Swipe down from the home screen of your watch and touch **Lock**.

**Unlock the screen**

To unlock the screen, hold the down button for 5 seconds.





## 2.3 Weather reports

You can view the weather information for your current location on your watch.

**Method 1:** Use the Weather watch face

Use the Weather watch face to view the latest weather information on the home screen.

**Method 2:** Use the weather card screen

Swipe right on the home screen to access the weather card screen to view information such as current location, current weather, temperature, and air quality.

**Method 3:** Use the Weather app

On the home screen, press the up button, swipe up or down on the screen, and touch **Weather** to view information such as current location, current weather, temperature, and air quality.



### NOTE

- To use the weather report feature, enable **Weather reports** in the Huawei Health app.
- The weather information displayed on your watch comes from the Huawei Health app, and may differ slightly from that displayed on your phone since the Huawei Health app and your phone obtain weather information from different service providers.

- Ensure that both GPS and the Huawei Health app of your phone have permission to acquire location information. For best results, select **Use GPS, WLAN, and mobile networks** as the positioning mode instead of **Use GPS only**.

# 3 Fitness and health

---

## 3.1 Daily activity records

Using its acceleration sensor and a gyroscope sensor, your watch can detect and monitor your daily activities, including your step count, calories burnt, activity intensity, and the amount of time you have spent standing.

Your watch can automatically identify your current activity, such as whether you are walking, running, sleeping, or stationary.

Your band will record your activity data automatically, including your step count, workout distance, workout time, and calories burnt after identifying whether you are walking or running.

To view your fitness data after a workout, use either of these two methods:

### **Method 1: View your fitness data on your band**

Press the up button, swipe up or down on the screen, and touch **Activity records**. Swipe up or down on the screen to view your calories burnt, workout distance, step count, and duration of moderate to high intensity activity.



### **Method 2: View your fitness data through the Huawei Health app.**

View your fitness data on the **Home** screen in the Huawei Health app.



#### **NOTE**

To view your fitness data in the Huawei Health app, ensure that your watch is connected to your phone via the Huawei Health app.

## **3.2 Start a workout**

Your watch supports several workout types, including Running Courses, Outdoor Run, Indoor Run, Outdoor Walk, Climb, Trail Run, Outdoor Cycle, Indoor Cycle, Pool swim, Open water, Triathlon, and Other.



## Starting Guided running

The watch provides you with professional running training courses from primary to advanced levels. These training courses provide a customized real-time running guide during a workout. You can select different courses during a workout, and can sync more courses from the Huawei Health app to the watch.

1. To start Guided running, press the up button, swipe up or down on the screen, go to **Workout > Running Courses**, and select a running course.
2. During the workout, press the up button to pause or end the workout. Press the down button to switch screens and view workout data.
3. After the workout, touch **Workout records** on the watch screen to view detailed workout data, including Training effects, General, Speed, Steps, Total height, Heart rate, Heart rate zones, Cadence, Pace, and VO2max.



### NOTE

You can also view detailed workout data on the **Exercise records** card in the Huawei Health app.

## Starting a workout

1. Press the up button, swipe up or down on the screen and touch **Workout**.
2. Swipe up or down on the screen to select a workout type. (Outdoor Run, Indoor Run, Outdoor Walk, Climb, Trail Run, Outdoor Cycle, Indoor Cycle, Pool swim, Open water, Triathlon, and Other. ) Before a workout, you are able to set the target, reminders, and display screen on your watch screen.
3. To start the workout, touch the start icon on the watch screen.
4. During the workout, press the up button to pause or end the workout. Press the down button to switch between screens and view workout data.

5. After the workout, touch **Workout records** on the watch screen to view detailed workout data.



**NOTE**

- If the workout distance or duration is too short, your watch will not record workout data.
- Touch the end icon after a workout ends to prolong battery life.

## 3.3 Workout status

Training status lets you know how effective your training is by analyzing your fitness level changes and training load for the past week, and assigning one of the following statuses: **Recovery**, **Productive**, **Peaking**, **Unproductive**, or **Detraining**. It also provides advice for the next stage of training.

You can also view your total workout load for the past week on the training load screen. Training load is classified as **High**, **Low**, or **Optimal**.

Press the up button, swipe on the screen to enter the **Workout status** screen, then swipe up on the screen to view your training status.



**NOTE**

To view your training status, you need to have workout records for at least one week.

## 3.4 Heart rate monitoring

Your watch includes an optical heart rate sensor, which can continuously monitor and record your heart rate throughout the day to help you keep track of your health and fitness. To use this feature, enable **Automatically measure heart rate** in the Huawei Health app.

### Heart rate measurement

1. Wear your watch while keeping still.
2. To measure your heart rate, press the up button, swipe up or down, and touch **Heart rate**.



 **NOTE**

To ensure accurate heart rate measurement, wear the watch normally and ensure the strap is securely fastened. Make sure that the watch contacts your skin directly without any obstructions.

## Heart rate measurement during a workout

During a workout, your watch can display your real-time heart rate and heart rate interval, and notify you when your heart rate exceeds the upper limit. For best training results, you are advised to choose a workout based on your heart rate interval.

- Setting the heart rate interval calculation method

The heart rate interval can be calculated based on maximum heart rate percentage or HRR percentage. To set the heart rate interval calculation method, open the Huawei Health app, go to **Me > Settings > Heart rate interval and warning > Calculation method**, and select either **Maximum heart rate percentage** or **HRR percentage**.

 **NOTE**

- If you select **Maximum heart rate percentage** as the calculation method, the heart rate interval for different types of workout activities (Extreme, Anaerobic, Aerobic, Fat-burning, and Warm-up) is calculated based on your maximum heart rate ("220 – your age" by default). Heart rate = Maximum heart rate x Maximum heart rate percentage
- If you select HRR percentage as the calculation method, the heart rate interval for different types of workout activities (Advanced anaerobic, Basic anaerobic, Lactic acid, Advanced aerobic, and Basic aerobic) is calculated based on your heart rate reserve (HRmax – HRrest). Heart rate = Heart rate reserve x Heart rate reserve percentage + Resting heart rate.
- The heart rate zone calculation method for a running course is not affected by the Huawei Health app settings. It is calculated based on Heart Rate Reserve (HRR) percentage for most running courses.
- Measuring your heart rate during a workout
  1. After you start a workout, swipe on the watch screen to check your real-time heart rate and heart rate interval.

2. After your workout ends, you can check your average heart rate, maximum heart rate, and heart rate interval under **Workout records** on your watch.
3. You can view your heart rate chart, maximum heart rate, and average heart rate for each workout on the exercise record screen in the Huawei Health App.



**NOTE**

- If you remove your watch during a workout, your watch will stop displaying your heart rate. Measurement will resume when you wear your watch again.
- Your watch can measure your heart rate when you connect it to your phone and start a workout using the Huawei Health app.

## Continuous heart rate monitoring

To enable this feature, connect your watch to your phone using the Huawei Health app, and enable **Continuous heart rate monitoring** in the Huawei Health app.

## Resting heart rate measurement

Resting heart rate refers to your heart rate when you are awake and in a state of rest, and is a general indicator of your cardiac health.

The best time to measure your resting heart rate is right after you wake up in the morning. As your watch's automatic heart rate measurement measures your heart rate throughout the day, the resting heart rate displayed may not be the same as your morning measurement.

To measure your resting heart rate automatically, enable **Continuous heart rate monitoring** in the Huawei Health app.



**NOTE**

If you disable **Continuous heart rate monitoring** after checking your resting heart rate, the resting heart rate displayed in the Huawei Health app will remain at the last measured value.

## 3.5 Sleep tracking

Your watch tracks your sleep quality when you wear it while sleeping. It can automatically detect when you fall asleep, wake up, and whether you are in light or deep sleep. You can also view your sleep data in the Huawei Health app after you sync your sleep data with your phone.

You can view sleep data of the current day on your watch. Sleep data history can be viewed in the Huawei Health app.





You can enable **HUAWEI TruSleep™** in the Huawei Health app. TruSleep provides you with sleep quality analysis and suggestions to help you understand and improve your sleep quality.

After you enable **HUAWEI TruSleep™**, your watch will collect comprehensive sleep data to create its analysis. It can detect when you fall asleep, wake up, and whether you are in light, deep, or REM sleep. It will also detect the number of times you wake up and your breathing quality.

## 3.6 Syncing and sharing your fitness and health data

You can share your fitness and workout data to third-party apps to compete with your friends.

To share your fitness data to a third-party app, open the Huawei Health app, go to **Me > Data sharing** and select the platform you want to share to. Follow the on-screen instructions specific to each platform.



### **NOTE**

This feature is available only in certain regions.

# 4 Messaging assistant

## 4.1 Incoming call notification

When your watch is connected to your phone and you receive a call, your watch will vibrate and display the caller's number and name.

 **NOTE**

- The incoming call information displayed on your watch matches the information displayed on your phone. If the caller is unknown, the phone number will be displayed. If you have the number saved in your contacts, the caller's name will be displayed.
- Your watch will not vibrate for incoming calls when **Do not disturb** is enabled.

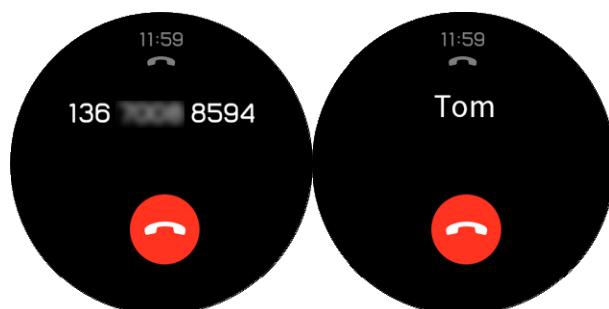

## 4.2 Rejecting an incoming call

When you receive an incoming call notification on your watch, you can reject the incoming call by touching Reject.

## 4.3 Messages reminders and content display

Your watch can notify you when a new message appears in your phone's status bar.

To enable this feature, use one of the following methods:

- **For Android users:** Open the Huawei Health app, go to **Me > My devices > Notifications** and enable **Notifications** for apps whose notifications you want to receive.

- **For iOS users:** Open the Huawei Health app, go to **Devices > Notifications management > Message alerts** and enable **Message alerts**. Also enable notifications in your phone **Settings** for apps whose notifications you want to receive.

You are able to receive alerts on your watch when new app notifications are displayed on your phone status bar.



When you receive a notification, swipe up or down on the watch screen to view message content. A maximum of 10 unread messages can be stored on your watch. If there are more than 10 unread messages, only the latest 10 messages will be displayed.

 **NOTE**

- Your watch can display messages from the following apps: Messaging, Email, Calendar, and social apps.
- If you receive a new message when you are reading another message, your watch will not display the new message instantly. It will display new message after you delete the current message.
- When your watch is in **Do not disturb** or sleep mode, it will still receive notifications but will not alert you. You can swipe right on your watch home screen to view new messages.

## 4.4 Deleting a message

Swipe right on the screen to delete the current message. You can also touch **Clear All** at the bottom of the message list to delete all unread messages.

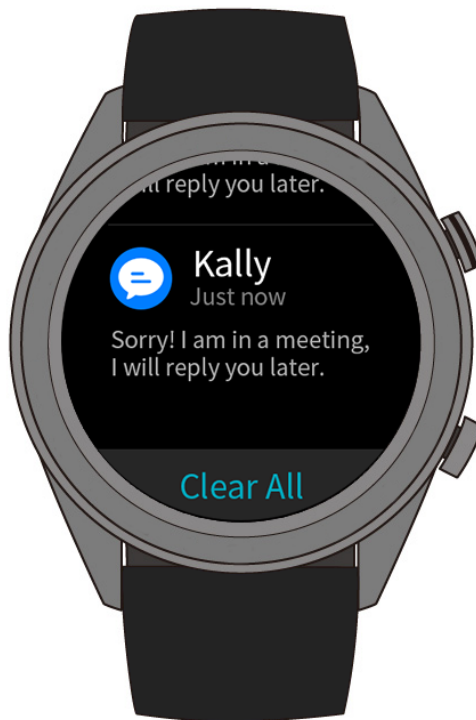

- **For Android users:** Messages will be automatically deleted from your watch once read or viewed on your phone.
- **For iOS users:** Messages will be automatically deleted from your watch once read or deleted on your phone.

# 5 Setting alarms

## 5.1 Setting a Smart alarm

You can set a Smart alarm for your watch in the Huawei Health app. The watch will wake you up when it detects that you are in light sleep. Waking up from light sleep is easier and leaves you naturally rested.

### For Android users:

1. Open the Huawei Health app, touch the watch icon in the upper right corner under **Home**, and go to **Alarm > Smart alarm**.
2. Set the alarm time, Smart wakeup, and repeat cycle.
3. Touch ✓ in the upper right corner to save your settings.
4. Swipe down on the Huawei Health app home screen to sync the alarm to your watch.





### For iOS users:

1. Open the Huawei Health app and touch **Devices**.
2. Touch the watch's Bluetooth name from the device list.

3. Go to **Alarm > Smart alarm**.
4. Set the alarm time, Smart wakeup, and repeat cycle.
5. Touch **Save**.
6. Swipe down on the Huawei Health app home screen to sync the alarm to your watch.

 **NOTE**

- When the watch's alarm activates, touch  to snooze for another 10 minutes. Touch  or press the up button to turn off the alarm.
- If you perform no operations when the alarm vibrates, it will automatically be turned off if you hit snooze three times.

## 5.2 Setting an Event alarm

**Method 1:** Set an Event alarm on your watch

1. On the home screen, press the up button and touch **Alarm**, and touch + to add an alarm.
2. Set the alarm time and repeat cycle, and touch **OK**.
3. Touch the alarm you have set to edit or modify the alarm.

**Method 2:** Set an Event alarm with the Huawei Health app

**For Android users:**

1. Open the Huawei Health app, and go to **Alarm > Event alarms** under **Devices**.
2. Set the alarm time, tag, and repeat cycle.
3. Touch ✓ in the upper right corner to save your settings.
4. Swipe down on the Huawei Health app's home screen to ensure the alarm is synced to the watch.





**For iOS users:**

1. Open the Huawei Health app, touch **Devices** and touch the watch's Bluetooth name in the device list.
2. Go to **Alarm > Event alarm**.
3. Set the alarm time, tag, and repeat cycle.
4. Touch **Save**.
5. Swipe down on the Huawei Health app's home screen to ensure the alarm is synced to the watch.



**NOTE**

- The Event alarm set on your watch can be synced to the Huawei Health app, and you are able to set at a maximum of five Event alarms.
- The Event alarm will vibrate to remind you at precisely the time you set. If you set a tag and time for the Event alarm, the watch will display the tag. Otherwise, only the time will be displayed.
- When the watch's alarm vibrates, touch the  on the screen to snooze for another 10 minutes, and touch  on the screen or press the up button to turn off the alarm.
- If you perform no operations when the alarm vibrates, it will automatically be turned off if you hit snooze three times.

# 6 Watch faces

## 6.1 Changing the watch face

You can change the watch face with any of these methods:

**Method 1:** Touch and hold the home screen to access the watch face selection menu.



**Method 2:** On the home screen, press the up button, go to **Settings > Display > Watch face**, then swipe right or left to choose the face you want to use.





## 6.2 Using Watch Face Store

Download and install more exquisite watch faces from the Watch Face Store.

1. Open the Huawei Health app and touch your watch name. Go to **Watch Faces > More** to find more watch faces.
2. Select your desired watch face and touch **Install**. After the installation is complete, your watch will display the new watch face automatically.
3. To use the new watch face, touch it and select **Set as default**.

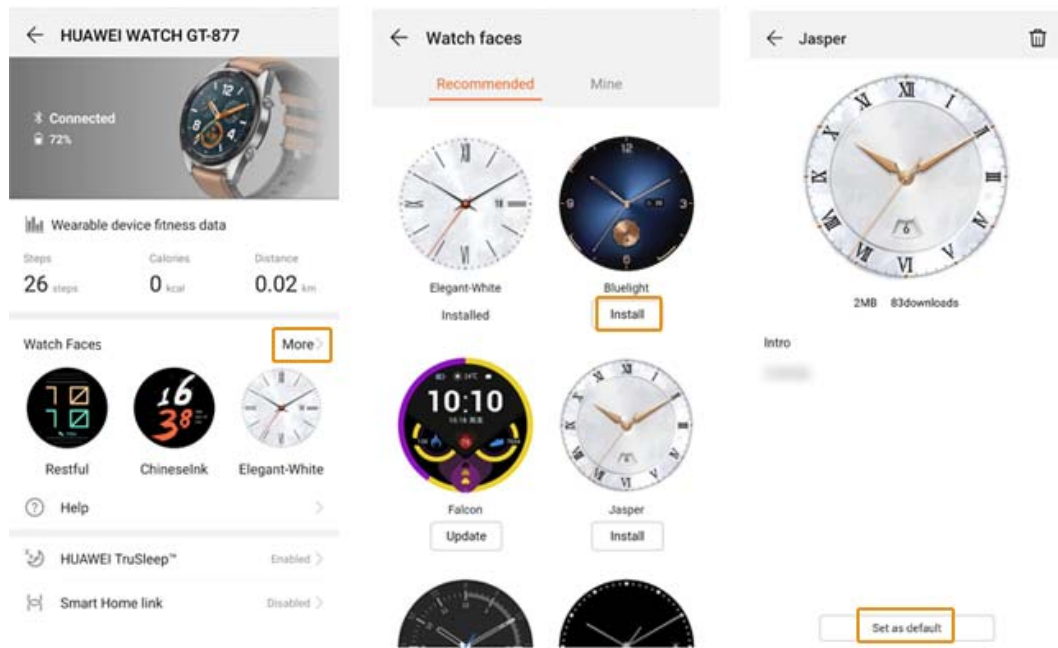

**NOTE**

Watch Face Store is not available on phones running iOS system. To use new watch faces on your iPhone, pair and connect your watch to a phone running Android system. Download and install your desired watch face, and re-connect your watch to your iPhone to use it.

# 7 Apps

## 7.1 Barometer

Your watch can measure the altitude and atmospheric pressure of your current location.

Press the up button of your watch, then swipe up or down on the screen, and touch **Barometer**. Your watch will display the current altitude and atmospheric pressure as well as a graph showing atmospheric changes during the current day.

**Altitude:**

Altitude measurement range: -800 to 8800 meters

**Atmospheric pressure:**

Atmospheric pressure measurement range: 300 to 1100 hPa



## 7.2 Compass

Need to find your bearings? Your watch can point you in the right direction.



Press the up button on your watch, then swipe up or down on the screen, and touch **Compass**. Move your watch according to the on-screen instructions to complete the calibration process. The compass will then be displayed.



## 7.3 Stopwatch and Timer

### Stopwatch

Press the up button on your watch, swipe up or down on the screen, and touch **Stopwatch**.

Touch  to start timing. Touch  to reset the stopwatch. Swipe right on the screen to close the stopwatch.

### Timer

By default, the watch provides eight countdown timer options: 1 minute, 3 minutes, 5 minutes, 10 minutes, 15 minutes, 30 minutes, 1 hour, and 2 hours.

Touch  to start the countdown. Touch  to pause, and touch  to close **Timer**.

You can also set a customized timer. Touch **Timer** and touch **Custom** at the bottom of the screen, then set your timer. Touch  to start the countdown.

## 7.4 Flashlight

Light up your surroundings with your watch's flashlight.

Press the up button on your watch, then swipe up or down on the screen, and touch **Flashlight**. Touch the screen to turn off the flashlight. Touch the screen again to turn it on. Swipe left to close **Flashlight**.

## 7.5 Find phone

Forgot where you left your phone? Locate it with your watch.

Press the up button on your watch and touch **Find my phone**, or swipe down on the home screen, and touch **Find Phone**. An animation will display on the screen. If your phone is within Bluetooth range, it will play a ringtone (even in Silent mode) to alert you of its location.



### NOTE

To enable this feature, ensure that the watch is connected to your phone, and the Huawei Health app is running in the background or foreground.



# 8 Updating and factory reset

## 8.1 Viewing version information

On your watch's home screen, press the up button, and go to **Settings > About**. You can then view your watch's system version.



## 8.2 Updating your watch and the Huawei Health app

Updates for your watch and the Huawei Health app are released from time to time, bringing user experience improvements. When a new update is available, follow the steps below to update your watch and the Huawei Health app.

## Updating your watch

**Method 1:** Connect your watch to your phone with the Huawei Health app. Open the Huawei Health app, and touch the watch icon in the upper right corner under **Home** (or go to **Me > My devices**). Touch **Firmware update** and follow the on-screen instructions to update your watch.

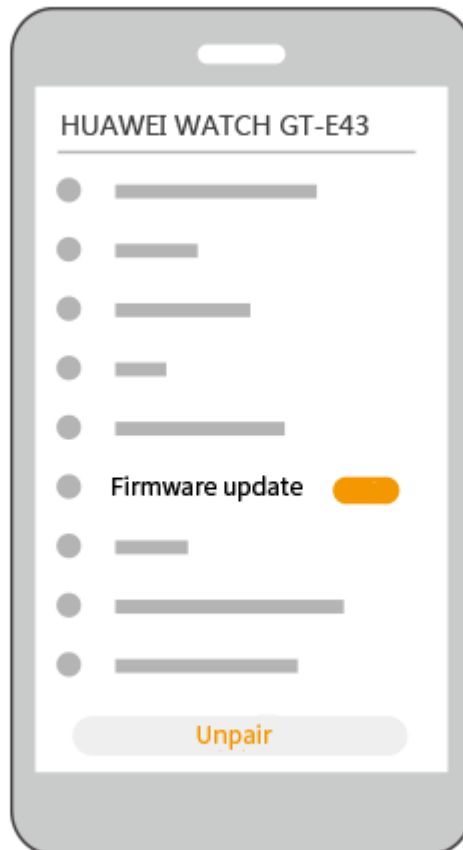

### Method 2:

- **For Android users:** Open the Huawei Health app, and touch the watch icon in the upper right corner under **Home** (or go to **Me > My devices**) and enable **Auto-download update packages over Wi-Fi**. When an update is available, a notification will be sent to your watch. Follow the on-screen instructions to update your watch.
- **For iOS users:** Open the Huawei Health app, touch the profile picture in the upper left corner, touch **Settings**, and enable **Auto-download update packages over Wi-Fi**. If an update is available, a notification will be sent to your watch. Follow the on-screen instructions to update your watch.



## Updating the Huawei Health app

**For Android users:** Open the Huawei Health app and go to **Me** > **Check for updates**.

**For iOS users:** Update the Huawei Health app in the App Store.



### NOTE

During an update, your watch will automatically disconnect from Bluetooth. It will reconnect once the update is complete.

## 8.3 Resetting your watch

You can restore your watch to its factory settings by following the steps below.



### NOTE

Resetting your watch will erase all your data.

**Method 1:** On your watch's home screen, press the up button, and go to **Settings** > **System** > **Reset**.





**Method 2:** Open the Huawei Health app and touch the device icon in the upper right corner under **Home**, then touch **Restore factory settings**.

## 8.4 Force restart

Hold the up button for 16 seconds or more to force restart your watch.



## 8.5 Viewing the Bluetooth name and MAC address

You can view your watch's Bluetooth name and MAC address with these methods:

**Method 1:** On your watch's home screen, press the up button and go to **Settings > About**. The **Device Name** is your watch's Bluetooth name. The 12 alphanumeric characters next to **MAC:** is your watch's MAC address.



**Method 2:** Your watch's Bluetooth name and MAC address are laser engraved on its back. The Bluetooth name is written as "HUAWEI WATCH GT-XXX". The 12 alphanumeric characters next to **MAC:** is your watch's MAC address.

**Method 3:**

1. Open the Huawei Health app and touch the watch icon in the upper right corner under **Home**. The information next to **Restore factory settings** is your watch's MAC address.
2. Go to **Me > My devices**. The watch's name under **My Devices** is its current Bluetooth name.

# 9 Maintenance

## 9.1 Water and dust resistance

Your watch has water resistance rating of 50 meters under ISO standard 22810:2010. You can wear your watch for water-related activities such as swimming in a pool or ocean. You should not wear your watch for snorkeling, water skiing, diving, or other activities involving deep or high-velocity water. You should not wear your watch to saunas, hot springs, or in a hot shower.

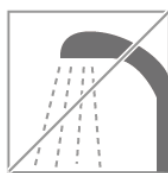

Your watch is resistant to dust in many typical situations (such as in a living room or office). It is not suitable for use in extreme dust environments.



### NOTE

- The leather strap is not water resistant and should not be exposed to liquids. Switch to a silicone rubber strap when you need to participate in water-related activities.
- If your watch's screen is wet, wipe it dry before use.
- Your watch's water resistance is not permanent and may wear off over time.

## 9.2 Cleaning and care

### Cleaning your watch

You should keep your watch and wrist clean and dry. To clean the watch, wipe the watch with a soft cloth. It is also recommended that you clean dust from its gaps regularly.

### Maintaining the watch face

Your watch's face is made of scratch-resistant glass and ceramic with a high degree of hardness. It can withstand normal wear and tear, but you should not drop it, or expose it to excessive force or sharp objects such as knives and stones.

### Light-color strap maintenance

To prevent discoloration, avoid letting your light-color strap contact dark clothing.

If your light-color strap gets dirty, dip a soft brush in clean water and use it to gently wipe the strap dry.

For stubborn stains, try rubbing a small amount of toothpaste onto the stained area.

### Leather strap maintenance

- Store your leather strap in a well-ventilated and dry place when you are not using it. If the strap gets dirty or wet, use a clean, soft cotton cloth to wipe the water or dirt off the strap, then let it air dry in a well-ventilated and cool location. When the strap becomes dry again, apply a layer of leather polish to its surface.
- Do not dry your leather strap by placing it in direct sunlight or with heating appliances such as microwaves or hairdryers. Doing so may cause your strap to expand or shrink.
- Do not expose your leather strap to rough or sharp objects.
- Do not contort the strap for extended periods. Doing so may damage your strap.
- Keep the strap away from flammable, acidic, and alkaline materials.
- Do not wear your leather strap too tightly or bend it excessively. Doing so may damage your strap.
- Do not punch extra holes in your leather strap. Doing so will damage the strap's protective layer and expose the raw leather to damage.

## 9.3 Adjusting or replacing the strap

### Adjusting the strap

Insert the strap into the T-buckle, adjust its length until it is comfortable on your wrist, and then secure it by inserting the T-buckle's prong into a strap hole.

### Replacing the strap

Unlock the spring pin and remove your current strap. Unlock the spring pin, insert your new strap, and then release the spring pin to attach it.

